

# Technical Information

## Proline Promag P 10

Electromagnetic flowmeter



Flowmeter for basic process applications with easy-to-use operation concept

### Application

- The bidirectional measuring principle is virtually independent of pressure, density, temperature and viscosity
- Specially for chemical and process applications with corrosive liquids

### Device properties

- Nominal diameter: max. DN 600 (24")
- All common Ex approvals
- Liner made of PTFE or PFA
- System integration with HART, Modbus RS485
- Flexible operation with app and optional display

### Your benefits

- Diverse applications – wide variety of wetted materials
- Energy-saving flow measurement – no pressure loss due to cross section constriction
- Maintenance-free – no moving parts
- Optimum usability – operation with mobile devices and SmartBlue app or display with touch screen
- Simple, time-saving commissioning – guided parameterization in advance and in the field
- Integrated verification – Heartbeat Technology

## Table of contents

<b>About this document</b>	<b>4</b>	Vibration-resistance and shock-resistance	49
Symbols	4	Electromagnetic compatibility (EMC)	49
Associated documentation	4		
Ordering information	4		
Registered trademarks	6		
<b>Function and system design</b>	<b>8</b>	<b>Process</b>	<b>52</b>
Measuring principle	8	Medium temperature range	52
Product design	8	Conductivity	53
IT security	9	Flow limit	53
Device-specific IT security	9	Pressure-temperature ratings	54
		Pressure tightness	56
		Pressure loss	57
		<b>Mechanical construction</b>	<b>60</b>
<b>Input</b>	<b>12</b>	Weight	60
Measured variable	12	Measuring pipe specification	61
Operable flow range	12	Materials	61
Measuring range	12	Fitted electrodes	63
		Surface roughness	63
<b>Output</b>	<b>16</b>	<b>Dimensions in SI units</b>	<b>66</b>
Output versions	16	Compact version	66
Output signal	16	Remote version	69
Signal on alarm	19	Fixed flange	71
Low flow cut off	19	Lap joint flange	81
Ex connection data	19	Lap joint flange, stamped plate	84
Galvanic isolation	19	Accessories	85
Protocol-specific data	20		
<b>Power supply</b>	<b>22</b>	<b>Dimensions in US units</b>	<b>88</b>
Terminal assignment	22	Compact version	88
Supply voltage	22	Remote version	91
Power consumption	22	Fixed flange	93
Current consumption	22	Lap joint flange	94
Power supply failure	23	Accessories	95
Electrical connection	23		
Potential equalization	28	<b>Local display</b>	<b>98</b>
Terminals	30	Operating concept	98
Cable entries	30	Operating options	98
Overvoltage protection	31	Operating tools	99
<b>Cable specification</b>	<b>34</b>	<b>Certificates and approvals</b>	<b>102</b>
Requirements for connecting cable	34	Ex approval	102
Ground cable requirements	34	Non-Ex approval	102
Connecting cable requirements	34	Pressure Equipment Directive	102
		HART certification	102
<b>Performance characteristics</b>	<b>38</b>	Radio approval	102
Reference operating conditions	38	Additional approvals	102
Maximum measured error	38	Other standards and guidelines	102
Repeatability	38		
Influence of ambient temperature	38	<b>Application packages</b>	<b>106</b>
		Use	106
<b>Installation</b>	<b>40</b>	Heartbeat Verification + Monitoring	106
Installation conditions	40		
		<b>Accessories</b>	<b>108</b>
<b>Environment</b>	<b>48</b>	Device-specific accessories	108
Ambient temperature range	48	Communication-specific accessories	109
Storage temperature	48	Service-specific accessory	109
Relative humidity	48	System components	110
Operating height	48		
Degree of protection	48		





## About this document

---







Symbols	4
Associated documentation	4
Ordering information	4
Registered trademarks	6

## Symbols



### Electronics

-  Direct current
-  Alternating current
-  Direct current and alternating current
-  Terminal connection for potential equalization

### Types of information

-  Preferred procedures, processes or actions
-  Permitted procedures, processes or actions
-  Forbidden procedures, processes or actions
-  Additional information
-  Reference to documentation
-  Reference to page
-  Reference to graphic

### Explosion protection

-  Hazardous area
-  Non-hazardous area

## Associated documentation

Technical Information	Overview of the device with the most important technical data.
Operating Instructions	All the information that is required in the various phases of the life cycle of the device: from product identification, incoming acceptance and storage, to mounting, connection, operation and commissioning through to troubleshooting, maintenance and disposal as well as the technical data and dimensions.
Sensor Brief Operating Instructions	Incoming acceptance, transport, storage and mounting of the device.
Transmitter Brief Operating Instructions	Electrical connection and commissioning of the device.
Description of Parameters	Detailed explanation of the menus and parameters.
Safety Instructions	Documents for the use of the device in hazardous areas.
Special Documentation	Documents with more detailed information on specific topics.
Installation Instructions	Installation of spare parts and accessories.

-  The device documentation is available online on the device product page and in the Downloads area: [www.endress.com](http://www.endress.com)

## Ordering information

Detailed ordering information is available from your nearest sales organization [www.addresses.endress.com](http://www.addresses.endress.com) or in the Product Configurator at [www.endress.com](http://www.endress.com):

1. Select the product using the filters and search field.
2. Open the product page.

3. Select **Configuration**.



**Product Configurator - the tool for individual product configuration**

- Up-to-the-minute configuration data
- Depending on the device: Direct input of measuring point-specific information such as measuring range or operating language
- Automatic verification of exclusion criteria
- Automatic creation of the order code and its breakdown in PDF or Excel output format
- Ability to order directly in the Endress+Hauser Online Shop

### Registered trademarks

#### **HART®**

Registered trademark of the FieldComm Group, Austin, USA

#### **Modbus®**

Registered trademark of SCHNEIDER AUTOMATION, INC.

#### **Bluetooth®**

The Bluetooth word mark and Bluetooth logos are registered trademarks of Bluetooth SIG, Inc. and any use of such marks by Endress+Hauser is under license. Other trademarks and trade names are those of their respective owners.

#### **Apple®**

Apple, the Apple logo, iPhone, and iPod touch are trademarks of Apple Inc., registered in the U.S. and other countries. App Store is a service mark of Apple Inc.

#### **Android®**

Android, Google Play and the Google Play logo are trademarks of Google Inc.

## Function and system design

---

Measuring principle	8
Product design	8
IT security	9
Device-specific IT security	9

## Measuring principle

Following *Faraday's law of magnetic induction*, a voltage is induced in a conductor moving through a magnetic field.

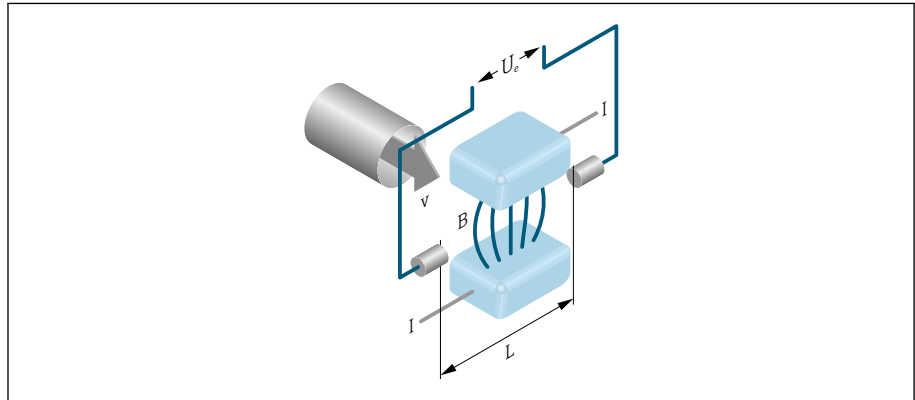

A0028962

- $U_e$  Induced voltage  
 $B$  Magnetic induction (magnetic field)  
 $L$  Electrode spacing  
 $I$  Current  
 $v$  Flow velocity

In the electromagnetic measuring principle, the flowing medium is the moving conductor. The voltage induced ( $U_e$ ) is proportional to the flow velocity ( $v$ ) and is supplied to the amplifier by means of two measuring electrodes. The flow volume ( $Q$ ) is calculated via the pipe cross-section ( $A$ ). The DC magnetic field is generated by a switched direct current of alternating polarity.

### Formulae for calculation

- Induced voltage  $U_e = B \cdot L \cdot v$
- Volume flow  $Q = A \cdot v$

## Product design

The device consists of a transmitter and a sensor.

Two device versions are available:

- Compact version – transmitter and sensor form a mechanical unit.
- Remote version - transmitter and sensor are mounted in separate locations.

### Compact version

The transmitter and sensor form a mechanical unit.

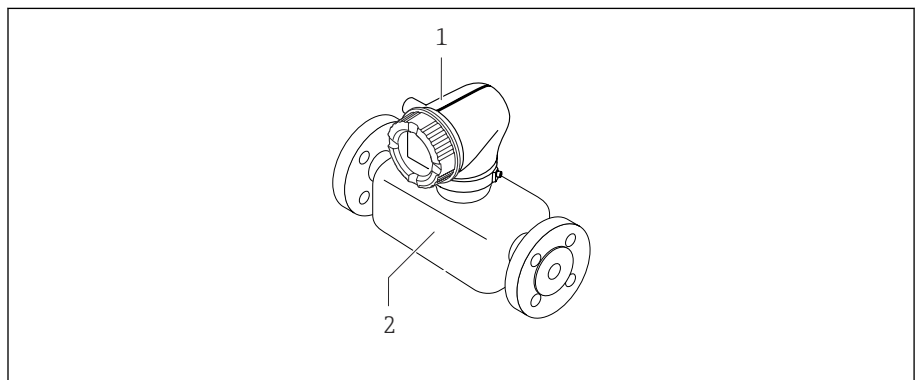

A0008262

- 1 Transmitter  
 2 Sensor



**Remote version**

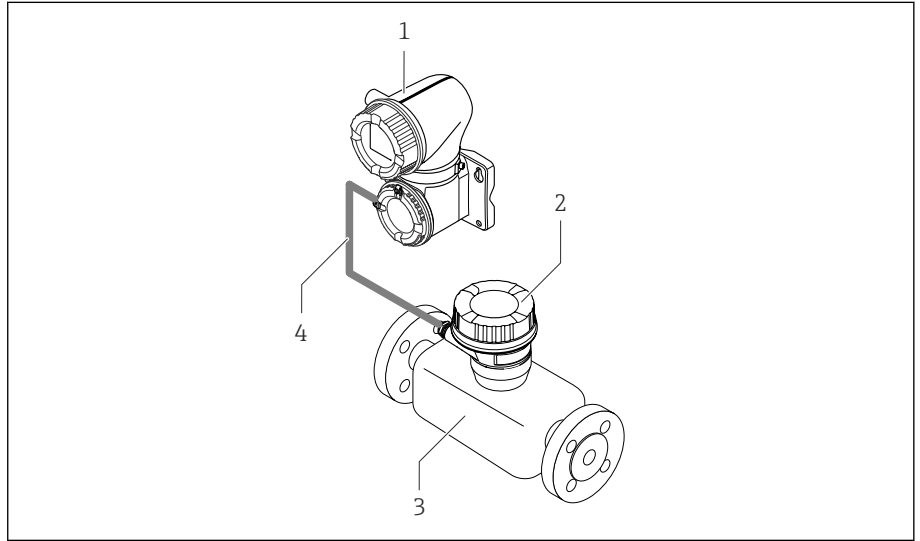

The transmitter and sensor are mounted in physically separate locations.



A0028196

- 1 Transmitter
- 2 Sensor connection housing
- 3 Sensor
- 4 Connecting cable

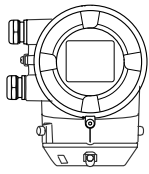
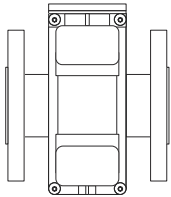
**Measuring system**

Proline 10 transmitter	Promag P sensor
 <p>Compact version</p>	
  <p>Remote version</p>	

**IT security**

We only provide a warranty if the device is installed and used as described in the Operating Instructions. The device is equipped with security mechanisms to protect it against any inadvertent changes to the device settings.

IT security measures in line with operators' security standards and designed to provide additional protection for the device and device data transfer must be implemented by the operators themselves.

**Device-specific IT security**

**Access via Bluetooth**

Secure signal transmission via Bluetooth uses an encryption method tested by the Fraunhofer Institute.

- Without the SmartBlue App, the device is not visible via Bluetooth.
- Only one point-to-point connection is established between the device and a smartphone or tablet.

### Access via the SmartBlue app

Two access levels (user roles) are defined for the device: the **Operator** user role and the **Maintenance** user role. The **Maintenance** user role is configured when the device leaves the factory.

If a user-specific access code is not defined (in the Enter access code parameter), the default setting **0000** continues to apply and the **Maintenance** user role is automatically enabled. The device's configuration data are not write-protected and can be edited at all times.

If a user-specific access code has been defined (in the Enter access code parameter), all the parameters are write-protected. The device is accessed with the **Operator** user role. When the user-specific access code is entered a second time, the **Maintenance** user role is enabled. All parameters can be written to.



For detailed information, see the "Description of Device Parameters" document pertaining to the device.

### Protecting access via a password

There are a variety of ways to protect against write access to the device parameters:

- User-specific access code:  
Protect write access to the device parameters via all the interfaces.
- Bluetooth key:  
The password protects access and the connection between an operating unit, e.g. a smartphone or tablet, and the device via the Bluetooth interface.

#### General notes on the use of passwords

- The access code and Bluetooth key that are valid when the device is delivered must be redefined during commissioning.
- Follow the general rules for generating a secure password when defining and managing the access code and Bluetooth key.
- The user is responsible for the management and careful handling of the access code and Bluetooth key.

### Write protection switch

The entire operating menu can be locked via the write protection switch. The values of the parameters cannot be changed. Write protection is disabled when the device leaves the factory.

Write protection is enabled with the write protection switch on the back of the display module.

## Input

---

Measured variable	12
Operable flow range	12
Measuring range	12

### Measured variable

Direct measured variables	<ul style="list-style-type: none"> <li>▪ Volume flow (proportional to induced voltage)</li> <li>▪ Conductivity (order code for "Sensor Option", option CX)</li> </ul>
Calculated measured variables	Mass flow

### Operable flow range

Over 1000 : 1

### Measuring range

Typically  $v = 0.01$  to  $10$  m/s ( $0.03$  to  $33$  ft/s) with specified measuring accuracy

Electrical conductivity:

- $\geq 5$   $\mu\text{S/cm}$  for liquids in general
- $\geq 20$   $\mu\text{S/cm}$  for demineralized water

Flow characteristic values in SI units: DN 15 to 125 (½ to 4")

Nominal diameter		Recommended flow min./max. full scale value ( $v \sim 0.3/10$ m/s)	Full scale value current output ( $v \sim 2.5$ m/s)	Factory settings	
[mm]	[in]			Pulse value ( $\sim 2$ pulse/s)	Low flow cut off ( $v \sim 0.04$ m/s)
		[dm <sup>3</sup> /min]	[dm <sup>3</sup> /min]	[dm <sup>3</sup> ]	[dm <sup>3</sup> /min]
15	½	4 to 100	25	0.2	0.5
25	1	9 to 300	75	0.5	1
32	–	15 to 500	125	1	2
40	1 ½	25 to 700	200	1.5	3
50	2	35 to 1100	300	2.5	5
65	–	60 to 2000	500	5	8
80	3	90 to 3000	750	5	12
100	4	145 to 4700	1200	10	20
125	–	220 to 7500	1850	15	30

Flow characteristic values in SI units: DN 150 to 600 (6 to 24")

Nominal diameter		Recommended flow min./max. full scale value ( $v \sim 0.3/10$ m/s)	Full scale value current output ( $v \sim 2.5$ m/s)	Factory settings	
[mm]	[in]			Pulse value ( $\sim 2$ pulse/s)	Low flow cut off ( $v \sim 0.04$ m/s)
		[m <sup>3</sup> /h]	[m <sup>3</sup> /h]	[m <sup>3</sup> ]	[m <sup>3</sup> /h]
150	6	20 to 600	150	0.03	2.5
200	8	35 to 1100	300	0.05	5
250	10	55 to 1700	500	0.05	7.5
300	12	80 to 2400	750	0.1	10
350	14	110 to 3300	1000	0.1	15
400	16	140 to 4200	1200	0.15	20
450	18	180 to 5400	1500	0.25	25
500	20	220 to 6600	2000	0.25	30
600	24	310 to 9600	2500	0.3	40

Flow characteristic values in US units: ½ - 24" (DN 15 - 600)

Nominal diameter		Recommended flow min./max. full scale value (v ~ 0.3/10 m/s)	Full scale value current output (v ~ 2.5 m/s)	Factory settings	
[in]	[mm]			Pulse value (~ 2 pulse/s)	Low flow cut off (v ~ 0.04 m/s)
		[gal/min]	[gal/min]	[gal]	[gal/min]
½	15	1.0 to 27	6	0.1	0.15
1	25	2.5 to 80	18	0.2	0.25
1 ½	40	7 to 190	50	0.5	0.75
2	50	10 to 300	75	0.5	1.25
3	80	24 to 800	200	2	2.5
4	100	40 to 1250	300	2	4
6	150	90 to 2 650	600	5	12
8	200	155 to 4 850	1200	10	15
10	250	250 to 7 500	1500	15	30
12	300	350 to 10 600	2400	25	45
14	350	500 to 15 000	3600	30	60
16	400	600 to 19 000	4800	50	60
18	450	800 to 24 000	6000	50	90
20	500	1 000 to 30 000	7500	75	120
24	600	1 400 to 44 000	10500	100	180

## Output

---

Output versions	16
Output signal	16
Signal on alarm	19
Low flow cut off	19
Ex connection data	19
Galvanic isolation	19
Protocol-specific data	20

## Output versions

Order code for 020: output; input	Output version
Option B	<ul style="list-style-type: none"> <li>■ Current output 4 to 20 mA HART</li> <li>■ Pulse/frequency/switch output</li> </ul>
Option C	<ul style="list-style-type: none"> <li>■ Current output 4 to 20 mA HART Ex i</li> <li>■ Pulse/frequency/switch output Ex i</li> </ul>
Option M	<ul style="list-style-type: none"> <li>■ Modbus RS485</li> <li>■ Current output 4 to 20 mA</li> </ul>
Option U	<ul style="list-style-type: none"> <li>■ Modbus RS485 Ex i</li> <li>■ Current output 4 to 20 mA Ex i</li> </ul>

## Output signal

### Current output 4 to 20 mA HART / 4 to 20 mA HART Ex-i

Signal mode	Choose via terminal assignment: <ul style="list-style-type: none"> <li>■ Active</li> <li>■ Passive</li> </ul>
Current range	Can be set to: <ul style="list-style-type: none"> <li>■ 4 to 20 mA NAMUR</li> <li>■ 4 to 20 mA US</li> <li>■ 4 to 20 mA</li> <li>■ Fixed current</li> </ul>
Max. output current	21.5 mA
Open-circuit voltage	DC < 28.8 V (active)
Max. input voltage	DC 30 V (passive)
Max. load	400 Ω
Resolution	1 μA
Damping	Configurable: 0 to 999.9 s
Assignable measured variables	<ul style="list-style-type: none"> <li>■ Off</li> <li>■ Volume flow</li> <li>■ Mass flow</li> <li>■ Conductivity*</li> <li>■ Noise*</li> <li>■ Coil current shot time*</li> </ul> <p>* Visibility depends on order options or device settings</p>

### Modbus RS485

Physical interface	RS485 in accordance with EIA/TIA-485 standard
--------------------	---

### Current output 4 to 20 mA

Signal mode	Choose via terminal assignment: <ul style="list-style-type: none"> <li>■ Active</li> <li>■ Passive</li> </ul>
Current range	Can be set to: <ul style="list-style-type: none"> <li>■ 4 to 20 mA NAMUR</li> <li>■ 4 to 20 mA US</li> <li>■ 4 to 20 mA</li> <li>■ Fixed current</li> </ul>

<b>Max. output current</b>	21.5 mA
<b>Open-circuit voltage</b>	DC < 28.8 V (active)
<b>Max. input voltage</b>	DC 30 V (passive)
<b>Max. load</b>	400 Ω
<b>Resolution</b>	1 μA
<b>Damping</b>	Configurable: 0 to 999.9 s
<b>Assignable measured variables</b>	<ul style="list-style-type: none"> <li>▪ Off</li> <li>▪ Volume flow</li> <li>▪ Mass flow</li> <li>▪ Conductivity*</li> <li>▪ Noise*</li> <li>▪ Coil current shot time*</li> </ul> <p>* Visibility depends on order options or device settings</p>

### Pulse/frequency/switch output

<b>Function</b>	<p>Can be set to:</p> <ul style="list-style-type: none"> <li>▪ Pulse output</li> <li>▪ Frequency output</li> <li>▪ Switch output</li> </ul>
<b>Version</b>	<p>Open collector: Passive</p>
<b>Input values</b>	<ul style="list-style-type: none"> <li>▪ DC 10.4 to 30 V</li> <li>▪ Max. 140 mA</li> </ul>
<b>Voltage drop</b>	<ul style="list-style-type: none"> <li>▪ ≤ DC 2 V @ 100 mA</li> <li>▪ ≤ DC 2.5 V @ max. input current</li> </ul>

<b>Pulse output</b>	
<b>Pulse width</b>	Configurable: 0.05 to 2 000 ms
<b>Max. pulse rate</b>	10 000 Impulse/s
<b>Pulse value</b>	Configurable
<b>Assignable measured variables</b>	<ul style="list-style-type: none"> <li>▪ Volume flow</li> <li>▪ Mass flow</li> </ul>

<b>Frequency output</b>	
<b>Output frequency</b>	Configurable: end value frequency 2 to 10 000 Hz ( $f_{\max} = 12\,500$ Hz)
<b>Damping</b>	Configurable: 0 to 999.9 s
<b>Pulse/pause ratio</b>	1:1
<b>Assignable measured variables</b>	<ul style="list-style-type: none"> <li>▪ Off</li> <li>▪ Volume flow</li> <li>▪ Mass flow</li> <li>▪ Conductivity*</li> <li>▪ Noise*</li> <li>▪ Coil current shot time*</li> <li>▪ Reference electrode potential against PE*</li> </ul> <p>* Visibility depends on order options or device settings</p>



<b>Switch output</b>	
<b>Switching behavior</b>	Binary, conductive or non-conductive
<b>Switching delay</b>	Configurable: 0 to 100 s
<b>Number of switching cycles</b>	Unlimited
<b>Assignable functions</b>	<ul style="list-style-type: none"><li>■ Off</li><li>■ On</li><li>■ Diagnostic behavior:<ul style="list-style-type: none"><li>■ Alarm</li><li>■ Warning</li><li>■ Warning and alarm</li></ul></li><li>■ Limit value:<ul style="list-style-type: none"><li>■ Off</li><li>■ Volume flow</li><li>■ Mass flow</li><li>■ Flow velocity</li><li>■ Conductivity*</li><li>■ Corrected conductivity*</li><li>■ Totalizer 1...3</li></ul></li><li>■ Flow direction monitoring</li><li>■ Status<ul style="list-style-type: none"><li>■ Empty pipe detection</li><li>■ Low flow cut off</li></ul></li></ul> <p>* Visibility depends on order options or device settings</p>

### Signal on alarm

Output behavior in the event of a device alarm (failure mode)

#### HART

<b>Device diagnostics</b>	Device condition can be read out via HART Command 48
---------------------------	--

#### Modbus RS485

<b>Failure mode</b>	Selectable: <ul style="list-style-type: none"> <li>▪ NaN value instead of current value</li> <li>▪ Last valid value</li> </ul>
---------------------	--

#### Current output 4 to 20 mA

<b>4 to 20 mA</b>	Selectable: <ul style="list-style-type: none"> <li>▪ Min. value: 3.59 mA</li> <li>▪ Max. value: 21.5 mA</li> <li>▪ Freely definable value between: 3.59 to 21.5 mA</li> <li>▪ Actual value</li> <li>▪ Last valid value</li> </ul>
-------------------	---

#### Pulse/frequency/switch output

<b>Pulse output</b>	Selectable: <ul style="list-style-type: none"> <li>▪ Actual value</li> <li>▪ No pulses</li> </ul>
<b>Frequency output</b>	Selectable: <ul style="list-style-type: none"> <li>▪ Actual value</li> <li>▪ 0 Hz</li> <li>▪ Defined value: 0 to 12 500 Hz</li> </ul>
<b>Switch output</b>	Selectable: <ul style="list-style-type: none"> <li>▪ Current status</li> <li>▪ Open</li> <li>▪ Closed</li> </ul>

#### Low flow cut off

The switch points for low flow cut off are user-selectable.

#### Ex connection data

Pay attention to the documentation on Ex connection values .



Safety-related values and intrinsically safe values: Safety Instructions (XA)

#### Galvanic isolation

The outputs are galvanically isolated from one another and from earth.

## Protocol-specific data

### HART

Bus structure	The HART signal overlays the 4 to 20 mA current output.
Manufacturer ID	0x11
Device type ID	0x71
HART protocol revision	7
Device description files (DTM, DD)	Information and files under: <a href="http://www.endress.com">www.endress.com</a>
HART load	At least 250 Ω
System integration	Measured variables via HART protocol

### Modbus RS485

Physical interface	RS485 in accordance with EIA/TIA-485 standard
Terminating resistor	Not integrated
Protocol	Modbus Applications Protocol Specification V1.1
Response times	<ul style="list-style-type: none"> <li>▪ Direct data access: typically 25 to 50 ms</li> <li>▪ Auto-scan buffer (data range): typically 3 to 5 ms</li> </ul>
Device type	Slave
Slave address range	1 to 247
Broadcast address range	0
Function codes	<ul style="list-style-type: none"> <li>▪ 03: Read holding register</li> <li>▪ 04: Read input register</li> <li>▪ 06: Write single registers</li> <li>▪ 08: Diagnostics</li> <li>▪ 16: Write multiple registers</li> <li>▪ 23: Read/write multiple registers</li> </ul>
Broadcast messages	Supported by the following function codes: <ul style="list-style-type: none"> <li>▪ 06: Write single registers</li> <li>▪ 16: Write multiple registers</li> <li>▪ 23: Read/write multiple registers</li> </ul>
Supported baud rate	<ul style="list-style-type: none"> <li>▪ 1 200 BAUD</li> <li>▪ 2 400 BAUD</li> <li>▪ 4 800 BAUD</li> <li>▪ 9 600 BAUD</li> <li>▪ 19 200 BAUD</li> <li>▪ 38 400 BAUD</li> <li>▪ 57 600 BAUD</li> <li>▪ 115 200 BAUD</li> </ul>
Data transfer mode	RTU
Data access	Each parameter can be accessed via Modbus RS485.  For Modbus register information
System integration	Information on system integration . <ul style="list-style-type: none"> <li>▪ Modbus RS485 information</li> <li>▪ Function codes</li> <li>▪ Register information</li> <li>▪ Response time</li> <li>▪ Modbus data map</li> </ul>

## Power supply

---

Terminal assignment	22
Supply voltage	22
Power consumption	22
Current consumption	22
Power supply failure	23
Electrical connection	23
Potential equalization	28
Terminals	30
Cable entries	30
Overvoltage protection	31

## Terminal assignment



The terminal assignment is documented on an adhesive label.

The following terminal assignment is available:

*Current output 4 to 20 mA HART (active) and pulse/frequency/switch output*

Supply voltage		Output 1				Output 2	
1 (+)	2 (-)	26 (+)	27 (-)	24 (+)	25 (-)	22 (+)	23 (-)
L/+	N/-	Current output 4 to 20 mA HART (active)		-		Pulse/frequency/switch output (passive)	

*Current output 4 to 20 mA HART (passive) and pulse/frequency/switch output*

Supply voltage		Output 1				Output 2	
1 (+)	2 (-)	26 (+)	27 (-)	24 (+)	25 (-)	22 (+)	23 (-)
L/+	N/-	-		Current output 4 to 20 mA HART (passive)		Pulse/frequency/switch output (passive)	

*Modbus RS485 and current output 4 to 20 mA (active)*

Supply voltage		Output 1				Output 2	
1 (+)	2 (-)	26 (+)	27 (-)	24 (+)	25 (-)	22 (B)	23 (A)
L/+	N/-	Current output 4 to 20 mA (active)		-		Modbus RS485	

*Modbus RS485 and current output 4 to 20 mA (passive)*

Supply voltage		Output 1				Output 2	
1 (+)	2 (-)	26 (+)	27 (-)	24 (+)	25 (-)	22 (B)	23 (A)
L/+	N/-	-		Current output 4 to 20 mA (passive)		Modbus RS485	

## Supply voltage

Order code for "Power supply"	Terminal voltage	Frequency range
Option D	DC 24 V	-20 to +30 %
Option E	AC 100 to 240 V	-15 to +10 %
Option I	DC 24 V	-20 to +30 %
	AC 100 to 240 V	-15 to +10 %
Option M non-hazardous area	DC 24 V	-20 to +30 %
	AC 100 to 240 V	-15 to +10 %

## Power consumption

- Transmitter: max. 10 W (active power)
- Switch-on current: max. 36 A (< 5 ms) as per NAMUR Recommendation NE 21

## Current consumption

- Max. 400 mA (24 V)
- Max. 200 mA (110 V, 50/60 Hz; 230 V, 50/60 Hz)

### Power supply failure

- Totalizers stop at the last value measured.
- Device configuration remains unchanged.
- Error messages (incl. total operated hours) are stored.

### Electrical connection

#### Connections and terminal assignment, remote version connecting cable

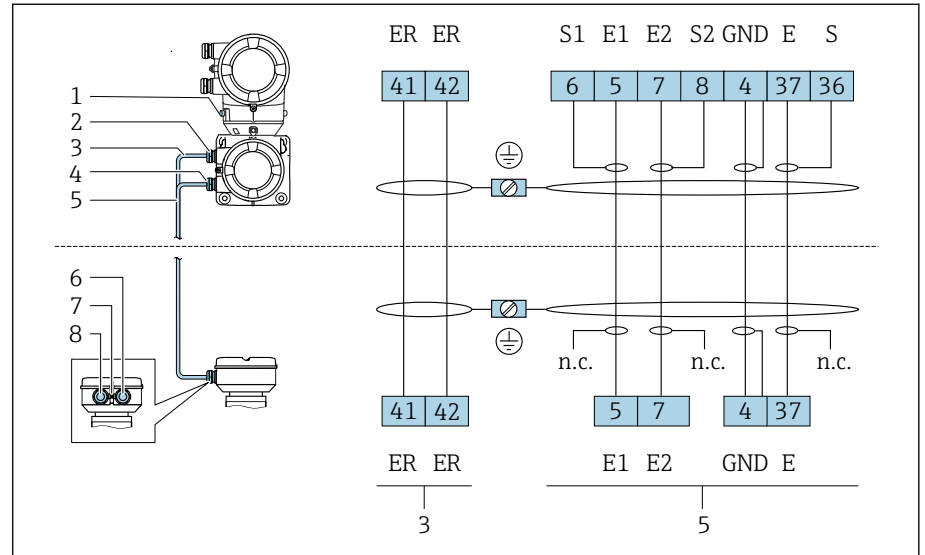

A0043474

- 1 Ground terminal, outer
- 2 Transmitter housing: cable entry for coil current cable
- 3 Coil current cable
- 4 Transmitter housing: cable entry for electrode cable
- 5 Electrode cable
- 6 Sensor connection housing: cable entry for electrode cable
- 7 Ground terminal, outer
- 8 Sensor connection housing: cable entry for coil current cable

### Transmitter terminal connections

**i** Terminal assignment → Terminal assignment, 22

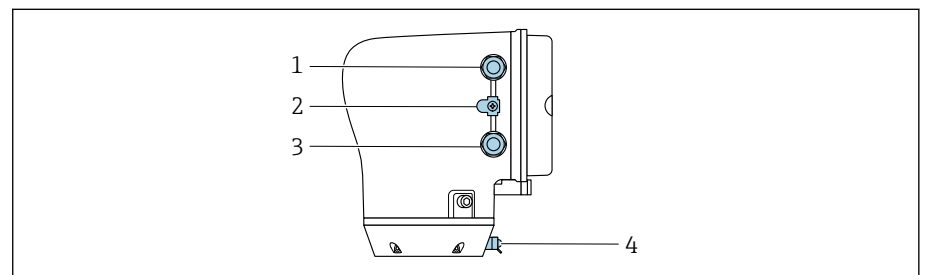

A0043283

- 1 Cable entry for power supply cable: supply voltage
- 2 Outer ground terminal: on transmitters made of polycarbonate with a metal pipe adapter
- 3 Cable entry for signal cable
- 4 Outer ground terminal

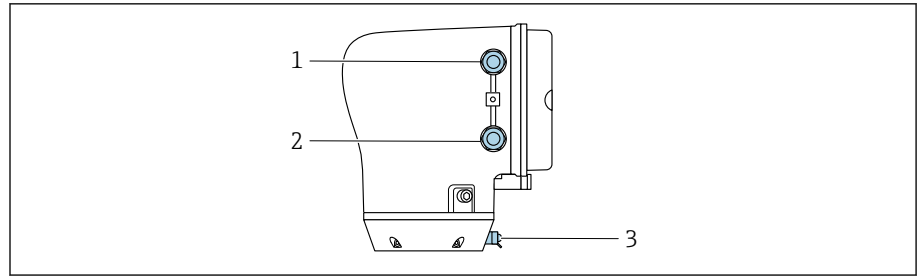

A0045438

- 1 Cable entry for power supply cable: supply voltage
- 2 Cable entry for signal cable
- 3 Outer ground terminal

Examples for electric terminals

Current output 4 to 20 mA HART (active)

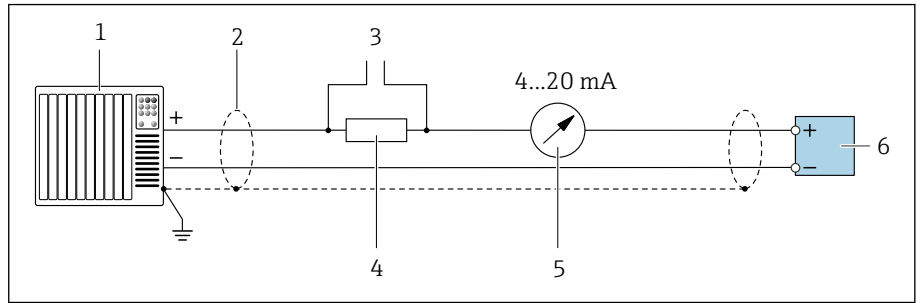

A0029055

- 1 Automation system with current input (e.g. PLC)
- 2 Cable shield
- 3 Connection for HART operating devices
- 4 Resistor for HART communication ( $\geq 250 \Omega$ ): observe max. load
- 5 Analog display unit: observe max. load.
- 6 Transmitter

Current output 4 to 20 mA HART (passive)

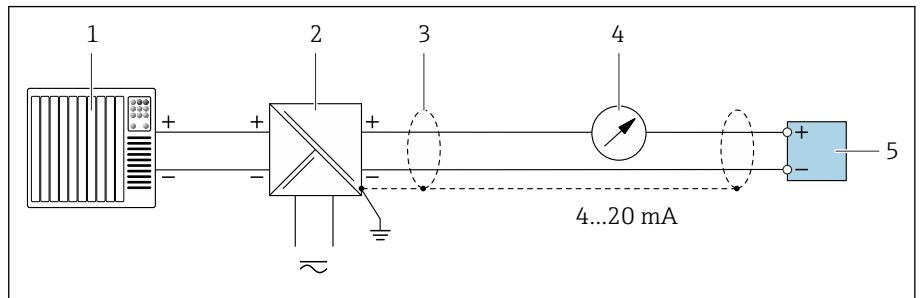

A0028762

- 1 Automation system with current input (e.g. PLC)
- 2 Active barrier for supply voltage (e.g. RN221N)
- 3 Cable shield
- 4 Analog display unit: observe max. load
- 5 Transmitter



HART input (passive)

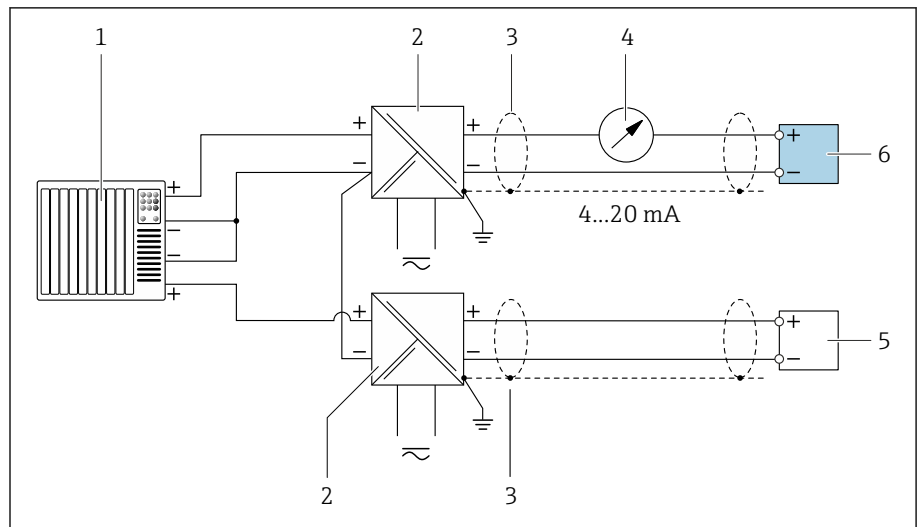

A0028763

1 Connection example for HART input with a common negative (passive)

- 1 Automation system with current input (e.g. PLC)
- 2 Active barrier for supply voltage (e.g. RN22 1N)
- 3 Cable shield
- 4 Analog display unit: observe max. load
- 5 Pressure transmitter (e.g. Cerabar M, Cerabar S: see requirements)
- 6 Transmitter

Modbus RS485

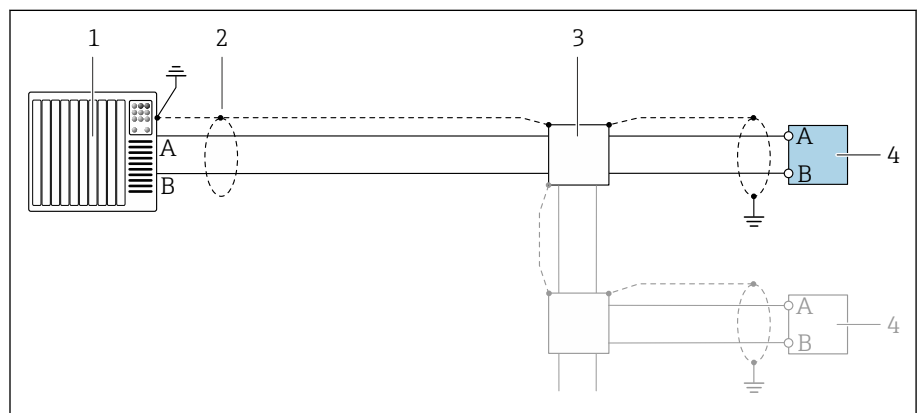

A0028765

2 Connection example for Modbus RS485, non-hazardous area and Zone 2; Class I, Division 2

- 1 Control system (e.g. PLC)
- 2 Cable shield
- 3 Distribution box
- 4 Transmitter

Current output 4 to 20 mA (active)

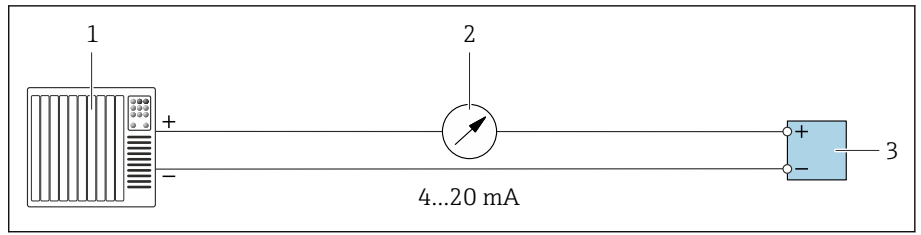

A0028758

- 1 Automation system with current input (e.g. PLC)
- 2 Analog display unit: observe max. load
- 3 Transmitter

Current output 4 to 20 mA (passive)

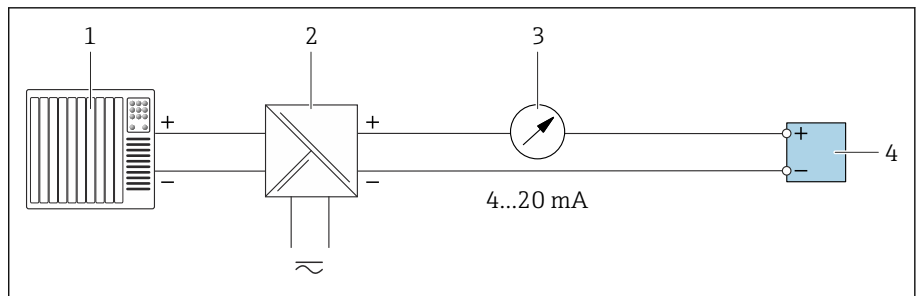

A0028759

- 1 Automation system with current input (e.g. PLC)
- 2 Active barrier for supply voltage (e.g. RN22 1N)
- 3 Analog display unit: observe max. load
- 4 Transmitter

Pulse/frequency output (passive)

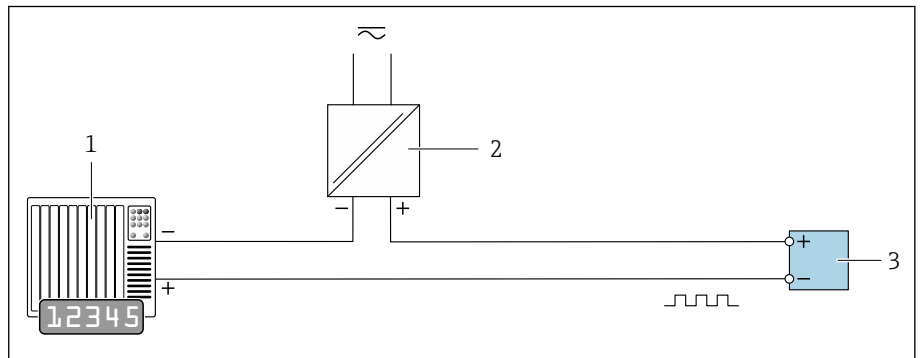

A0028761

- 1 Automation system with pulse output and frequency input (e.g. PLC with a 10 kΩ pull-up or pull-down resistor)
- 2 Supply voltage
- 3 Transmitter: observe input values

### Switch output (passive)

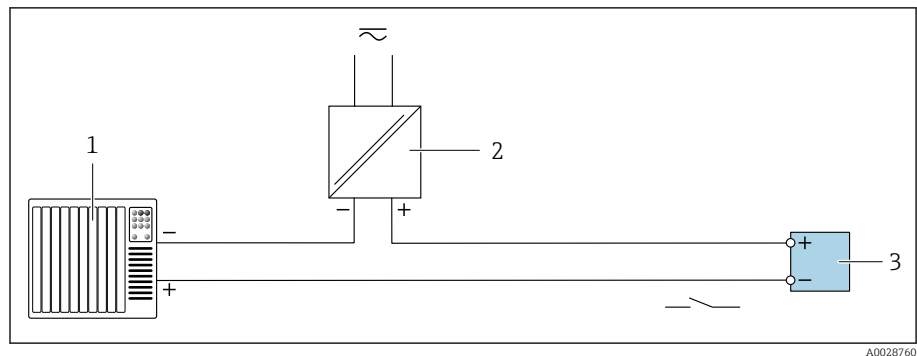

- 1 Automation system with switch input (e.g. PLC with a 10 kΩ pull-up or pull-down resistor)
- 2 Supply voltage
- 3 Transmitter: observe input values



## Potential equalization

### Introduction

Correct potential equalization (equipotential bonding) is a prerequisite for stable and reliable flow measurement. Inadequate or incorrect potential equalization can result in device failure and present a safety hazard.

The following requirements must be observed to ensure correct, trouble-free measurement:

- The principle that the medium, the sensor and the transmitter must be at the same electrical potential applies.
- Take in-company grounding guidelines, materials and the grounding conditions and potential conditions of the pipe into consideration.
- The necessary potential equalization connections must be established using a ground cable with a minimum cross-section of 6 mm<sup>2</sup> (0.0093 in<sup>2</sup>). Also use a cable lug.
- In the case of remote device versions, the ground terminal in the example always refers to the sensor and not to the transmitter.

 Accessories such as ground cables and ground disks can be ordered from Endress +Hauser → *Device-specific accessories*,  108

 For devices intended for use in hazardous areas, observe the instructions in the Ex documentation (XA).

### Abbreviations used

- PE (Protective Earth): potential at the potential equalization terminals of the device
- P<sub>p</sub> (Potential Pipe): potential of the pipe, measured at the flanges
- P<sub>M</sub> (Potential Medium): potential of the medium

### Connection examples for standard situations

#### Unlined and grounded metal pipe

- Potential equalization is via the measuring pipe.
- The medium is set to ground potential.

Starting conditions:

- Pipes are correctly grounded on both sides.
  - Pipes are conductive and at the same electrical potential as the medium
- Connect the connection housing of the transmitter or sensor to ground potential via the ground terminal provided for this purpose.

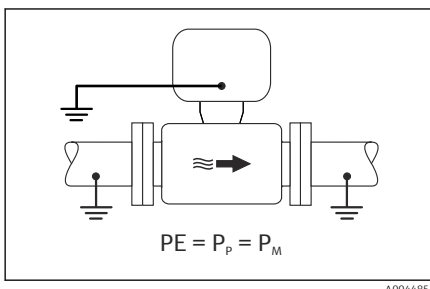

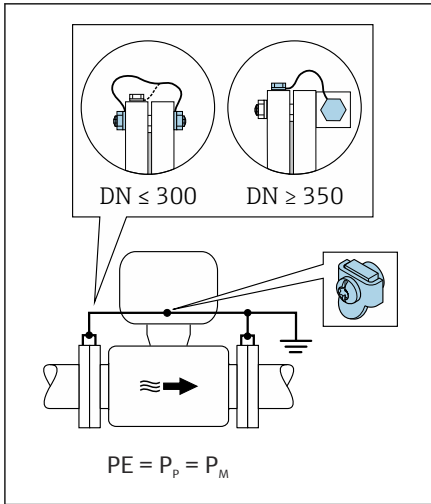

**Unlined metal pipe**

- Potential equalization is via the ground terminal and pipe flanges.
- The medium is set to ground potential.

Starting conditions:

- Pipes are not sufficiently grounded.
- Pipes are conductive and at the same electrical potential as the medium

1. Connect both sensor flanges to the pipe flange via a ground cable and ground them.
2. Connect the connection housing of the transmitter or sensor to ground potential via the ground terminal provided for this purpose.
3. For DN ≤ 300 (12"): Mount the ground cable directly on the conductive flange coating of the sensor with the flange screws.
4. For DN ≥ 350 (14"): Mount the ground cable directly on the metal transport bracket. Observe the screw tightening torques: see the Brief Operating Instructions for the sensor.

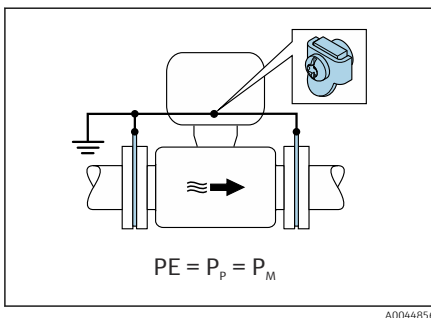

**Plastic pipe or pipe with insulating liner**

- Potential equalization is via the ground terminal and ground disks.
- The medium is set to ground potential.

Starting conditions:

- The pipe has an insulating effect.
- Low-impedance medium grounding close to the sensor is not guaranteed.
- Equalizing currents through the medium cannot be ruled out.

1. Connect the ground disks via the ground cable to the ground terminal of the connection housing of the transmitter or sensor.
2. Connect the connection to ground potential.

**Connection example with the potential of medium not equal to potential equalization connection without the "Floating measurement" option**

In these cases, the medium potential can differ from the potential of the device.

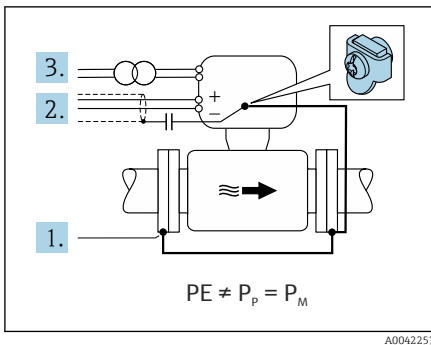

**Metal, ungrounded pipe**

The sensor and transmitter are installed in a way that provides electrical insulation from PE, e.g. applications for electrolytic processes or systems with cathodic protection.

Starting conditions:

- Unlined metal pipe
- Pipes with an electrically conductive liner

1. Connect the pipe flanges and transmitter via the ground cable.
2. Route the shielding of the signal lines via a capacitor (recommended value 1.5µF/50V).
3. Device connected to power supply such that it is floating in relation to the potential equalization connection (isolation transformer). This measure is not required in the case of 24V DC supply voltage without PE (= SELV power unit).

**Connection examples with the potential of medium not equal to potential equalization connection with the "Floating measurement" option**

In these cases, the medium potential can differ from the potential of the device.

**Introduction**

The "Floating measurement" option enables the galvanic isolation of the measuring system from the device potential. This minimizes harmful equalizing currents caused by

differences in potential between the medium and the device. The "Floating measurement" option is optionally available: order code for "Sensor option", option CV

#### Operating conditions for the use of the "Floating measurement" option

Device version	Compact version and remote version (length of connecting cable $\leq$ 10 m)
Differences in voltage between medium potential and device potential	As small as possible, usually in the mV range
Alternating voltage frequencies in the medium or at ground potential (PE)	Below typical power line frequency in the country

**i** To achieve the specified conductivity measuring accuracy, a conductivity calibration is recommended when the device is installed.

A full pipe adjustment is recommended when the device is installed.

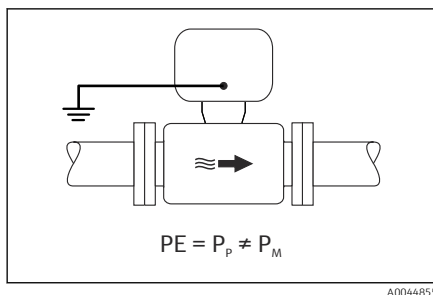

#### Plastic pipe

Sensor and transmitter are correctly grounded. A difference in potential can occur between the medium and potential equalization connection. Potential equalization between  $P_M$  and PE via the reference electrode is minimized with the "Floating measurement" option.

Starting conditions:

- The pipe has an insulating effect.
- Equalizing currents through the medium cannot be ruled out.

1. Use the "Floating measurement" option, while also observing the operating conditions for floating measurement.

2. Connect the connection housing of the transmitter or sensor to ground potential via the ground terminal provided for this purpose.

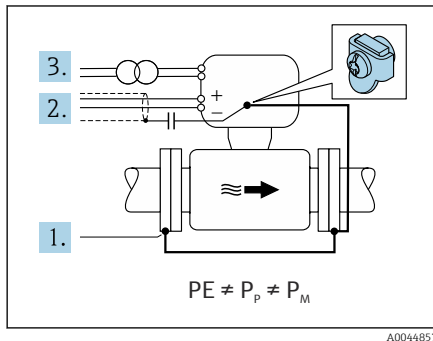

#### Metal, ungrounded pipe with insulating liner

The sensor and transmitter are installed in a way that provides electrical insulation from PE. The medium and pipe have different potentials. The "Floating measurement" option minimizes harmful equalizing currents between  $P_M$  and  $P_p$  via the reference electrode.

Starting conditions:

- Metal pipe with insulating liner
- Equalizing currents through the medium cannot be ruled out.

1. Connect the pipe flanges and transmitter via the ground cable.

2. Route the shielding of the signal cables via a capacitor (recommended value 1.5  $\mu$ F/50V).

3. Device connected to power supply such that it is floating in relation to the potential equalization connection (isolation transformer). This measure is not required in the case of 24V DC supply voltage without PE (= SELV power unit).

4. Use the "Floating measurement" option, while also observing the operating conditions for floating measurement.

#### Terminals

Spring terminals

- Suitable for strands and strands with ferrules.
- Conductor cross-section 0.2 to 2.5 mm<sup>2</sup> (24 to 12 AWG).

#### Cable entries

- Cable gland: M20  $\times$  1.5 for cable  $\varnothing$ 6 to 12 mm (0.24 to 0.47 in)
- Thread for cable entry:
  - NPT 1/2"
  - G 1/2", G 1/2" Ex d
  - M20

### Overvoltage protection

<b>Mains voltage fluctuations</b>	→ <i>Supply voltage</i> , ☰ 22
<b>Overvoltage category</b>	Overvoltage category II
<b>Short-term, temporary overvoltage</b>	Between cable and neutral conductor up to 1200 V for max. 5s
<b>Long-term, temporary overvoltage</b>	Up to 500 V between cable and ground

## Cable specification

---

Requirements for connecting cable	34
Ground cable requirements	34
Connecting cable requirements	34

## Requirements for connecting cable

### Electrical safety

As per applicable national regulations.

### Permitted temperature range

- Observe the installation guidelines that apply in the country of installation.
- The cables must be suitable for the minimum temperatures and maximum temperatures to be expected.

### Power supply cable (incl. conductor for the inner ground terminal)

- A standard installation cable is sufficient.
- Provide grounding according to applicable national codes and regulations.

### Signal cable

- Current output 4 to 20 mA HART:  
A shielded cable is recommended, observe the grounding concept of the facility.
- Pulse/frequency/switch output:  
Standard installation cable
- Modbus RS485:  
Cable type A according to EIA/TIA-485 standard is recommended
- Current output 4 to 20 mA:  
Standard installation cable

## Ground cable requirements

Copper wire: at least 6 mm<sup>2</sup> (0.0093 in<sup>2</sup>)

## Connecting cable requirements

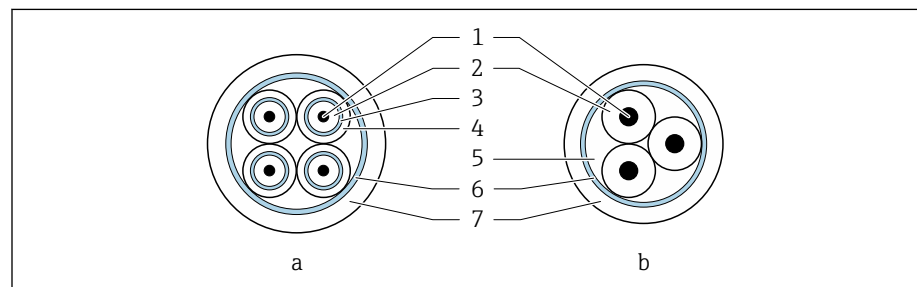

A0029151

3 Cable cross-section

- a* Electrode cable  
*b* Coil current cable
- 1 Core  
 2 Core insulation  
 3 Core shield  
 4 Core jacket  
 5 Core reinforcement  
 6 Cable shield  
 7 Outer jacket

### Armored connecting cable

Armored connecting cables with additional, metal reinforcing braid can be ordered from Endress+Hauser. Armored connecting cables are used:

- When laying the cable directly in the ground
- Where there is a risk of damage from rodents
- If using the device below IP68 degree of protection



## Electrode cable

<b>Design</b>	3×0.38 mm <sup>2</sup> (20 AWG) with common, braided copper shield (∅ ~ 9.5 mm (0.37 in)) and individual shielded cores If using the empty pipe detection (EPD) function: 4×0.38 mm <sup>2</sup> (20 AWG) with common, braided copper shield (∅ ~ 9.5 mm (0.37 in)) and individual shielded cores
<b>Conductor resistance</b>	≤ 50 Ω/km (0.015 Ω/ft)
<b>Capacitance: core/shield</b>	≤ 420 pF/m (128 pF/ft)
<b>Cable length</b>	Depends on the medium conductivity: maximum 200 m (656 ft)
<b>Cable lengths (available for order)</b>	5 m (15 ft), 10 m (30 ft), 20 m (60 ft) or variable length: maximum 200 m (656 ft) Armored cables: variable length up to maximum 200 m (656 ft)
<b>Operating temperature</b>	-20 to +80 °C (-4 to +176 °F)

## Coil current cable

<b>Design</b>	3×0.38 mm <sup>2</sup> (20 AWG) with common, braided copper shield (∅ ~ 9.5 mm (0.37 in)) and individual shielded cores
<b>Conductor resistance</b>	≤ 37 Ω/km (0.011 Ω/ft)
<b>Capacitance: core/shield</b>	≤ 120 pF/m (37 pF/ft)
<b>Cable length</b>	Depends on the medium conductivity, max. 200 m (656 ft)
<b>Cable lengths (available for order)</b>	5 m (15 ft), 10 m (30 ft), 20 m (60 ft) or variable length up to max. 200 m (656 ft) Armored cables: variable length up to max. 200 m (656 ft)
<b>Operating temperature</b>	-20 to +80 °C (-4 to +176 °F)
<b>Test voltage for cable insulation</b>	≤ AC 1 433 V rms 50/60 Hz or ≥ DC 2 026 V

## Performance characteristics

---

Reference operating conditions	38
Maximum measured error	38
Repeatability	38
Influence of ambient temperature	38

### Reference operating conditions

- Error limits based on ISO 20456:2017
- Water, typically: +15 to +45 °C (+59 to +113 °F); 0.5 to 7 bar (7.3 to 101 psi)
- Data as indicated in the calibration protocol
- Accuracy based on accredited calibration rigs according to ISO 17025

**i** To obtain measured errors, use the *Applicator* sizing tool → *Service-specific accessory*, 109

### Maximum measured error

o. r. = of reading

### Error limits under reference operating conditions

#### Volume flow

±0.5 % o. r. ±1 mm/s (±0.04 in/s)

**i** Fluctuations in the supply voltage do not have any effect within the specified range.

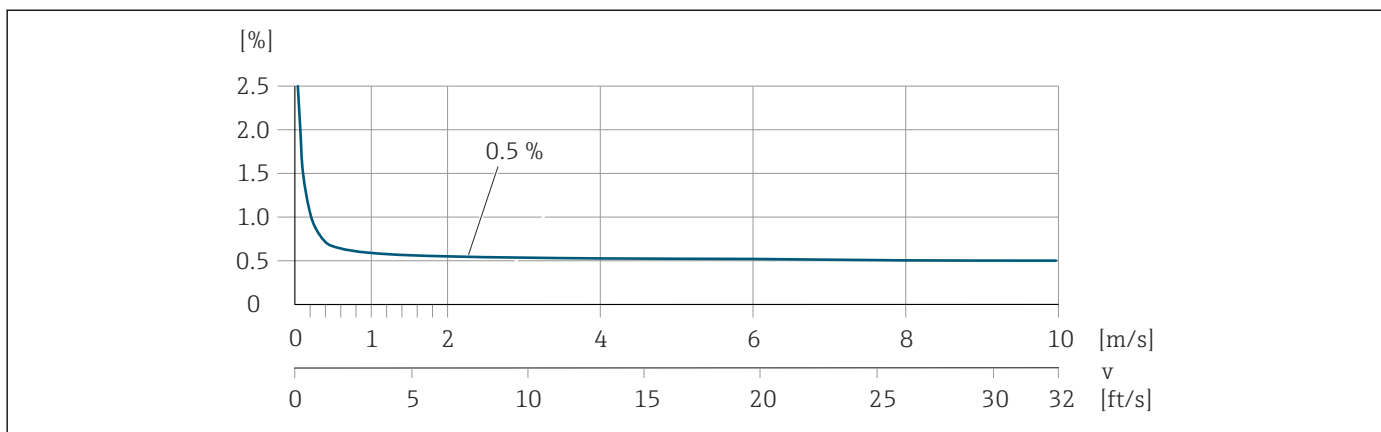

A0045827

#### Electrical conductivity

Max. measured error not specified.

### Accuracy of outputs

Current output	±5 µA
Pulse/frequency output	Max. ±100 ppm o. r. (across the entire ambient temperature range)

### Repeatability

Volume flow	Max. ±0.1 % o. r. ± 0.5 mm/s (0.02 in/s)
Electrical conductivity	Max. ±5 % o. r. (5 to 100 000 µS/cm)

### Influence of ambient temperature

Current output	Temperature coefficient max. 1 µA/°C
Pulse/frequency output	No additional effect. Is included in the accuracy.

# Installation

---

Installation conditions

40

## Installation conditions

### Flow direction

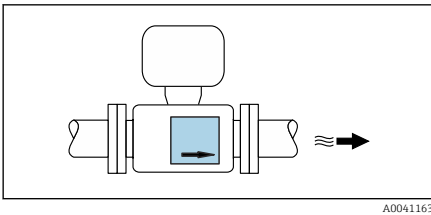

A0041163

Install the device in the direction of flow.



Note the direction of arrow on the nameplate.

### Installation with inlet runs and outlet runs

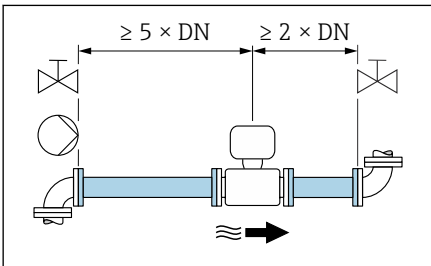

A0028997

Ensure straight, undisturbed inlet and outlet runs.



To avoid negative pressure and to comply with accuracy specifications, install the sensor upstream from assemblies that produce turbulence (e.g. valves, T-sections) and downstream from pumps → *Installation near pumps*, 43.

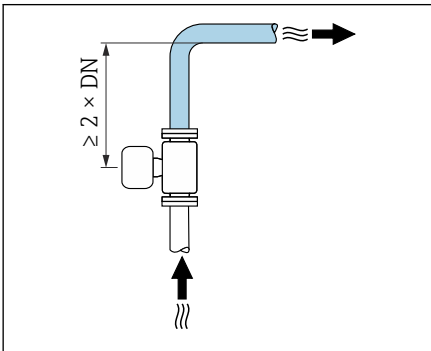

A0042132

Keep a sufficient distance to the next pipe elbow.

### Orientations

#### Vertical orientation, upward direction of flow

For all applications.

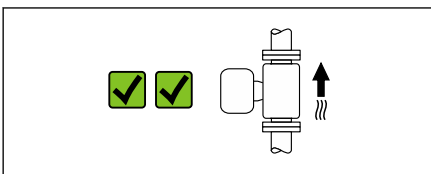

A0041159

#### Horizontal orientation, transmitter at top

This orientation is suitable for the following applications:

- For low process temperatures in order to maintain the minimum ambient temperature for the transmitter.
- For empty pipe detection, even in the case of empty or partially filled measuring pipes.

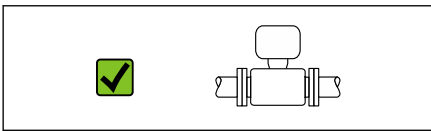

A0041160

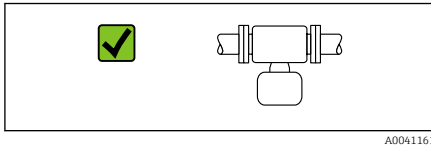

**Horizontal orientation, transmitter at bottom**

This orientation is suitable for the following applications:

- For high process temperatures in order to maintain the maximum ambient temperature for the transmitter.
- To prevent the electronics from overheating in the event of strong heat formation (e.g. CIP or SIP cleaning process), install the measuring device with the transmitter part pointing downwards.

This orientation is not suitable for the following applications:  
If empty pipe detection is to be used.

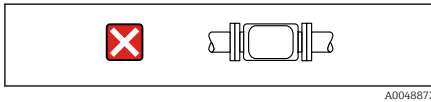

**Horizontal orientation, transmitter at side**

This orientation is not suitable

*Vertical*

Optimum for self-emptying pipe systems and for use in conjunction with empty pipe detection.

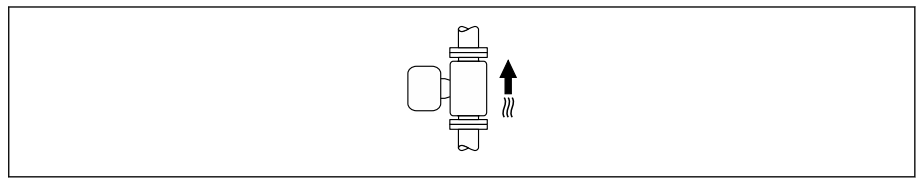

*Horizontal*

- Ideally, the measuring electrode plane should be horizontal. This prevents brief insulation of the measuring electrodes by entrained air bubbles.
- Empty pipe detection only works if the transmitter housing is pointing upwards as otherwise there is no guarantee that the empty pipe detection function will actually respond to a partially filled or empty measuring tube.

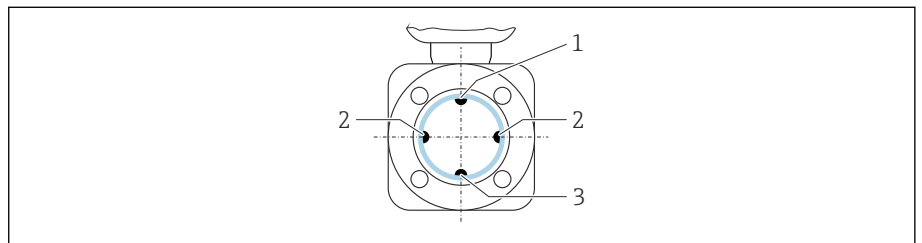

- 1 EPD electrode for empty pipe detection
- 2 Measuring electrodes for signal detection
- 3 Reference electrode for potential equalization

**i** Measuring devices with tantalum or platinum electrodes can be ordered without an EPD electrode. In this case, empty pipe detection is performed via the measuring electrodes.

### Mounting locations

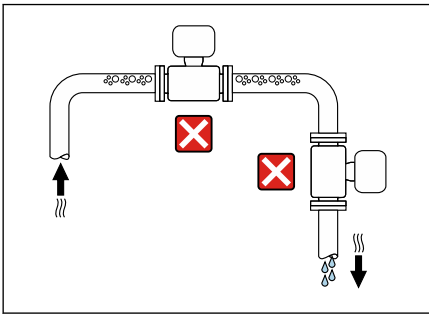

A0042131

- Do not install the device at the highest point of the pipe.
- Do not install the device upstream from a free pipe outlet in a down pipe.

The device should ideally be installed in an ascending pipe.

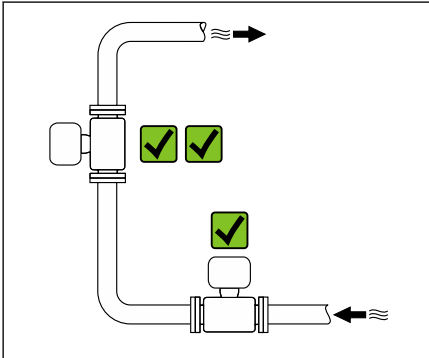

A0042317

### Installation near control valves

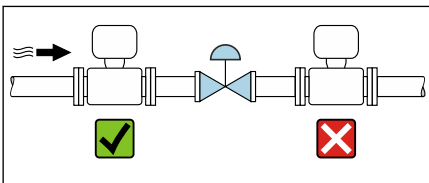

A0041091

Install the device in the direction of flow upstream from the control valve.

### Installation upstream from a down pipe

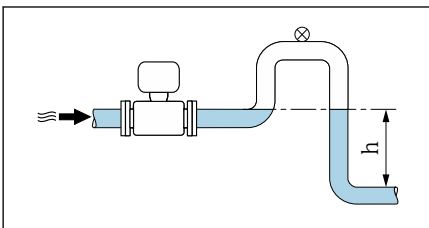

A0041089

#### NOTICE

**Negative pressure in the measuring pipe can damage the liner!**

- ▶ If installing upstream from down pipes with a length  $h \geq 5$  m (16.4 ft): install a siphon with a vent valve downstream from the device.

**i** This arrangement prevents the flow of liquid stopping in the pipe and air entrainment.

### Installation with partially filled pipes

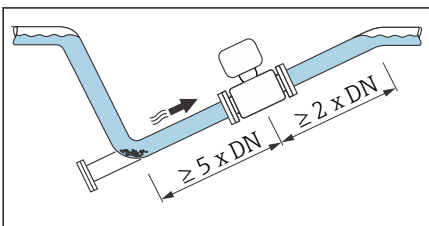

A0041088

- Partially filled pipes with a gradient require a drain-type configuration.
- The installation of a cleaning valve is recommended.

### Installation near pumps

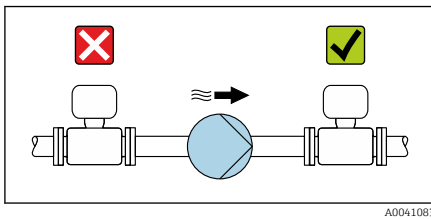

#### NOTICE

#### Negative pressure in the measuring pipe can damage the liner!

- ▶ Install the device in the direction of flow downstream from the pump.
- ▶ Install pulsation dampers if reciprocating, diaphragm or peristaltic pumps are used.



- Information on the liner's resistance to partial vacuum ([Verweisziel existiert nicht, aber @y.link.required=true](#))
- Information on the measuring system's resistance to vibration and shock → *Vibration-resistance and shock-resistance*, 49

### Installation of very heavy devices

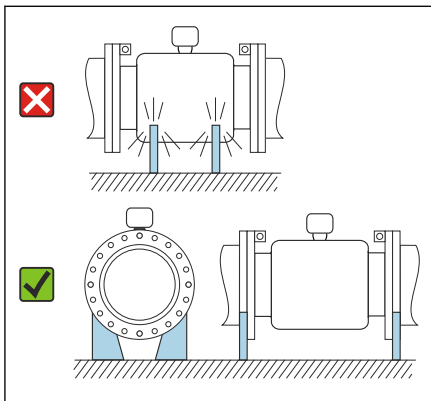

Support is required with nominal diameters of  $DN \geq 350$  (14") and higher.

#### NOTICE

#### Damage to the device!

If incorrect support is provided, the sensor housing could buckle and the internal magnetic coils could be damaged.

- ▶ Only provide supports at the pipe flanges.

### Pipe vibrations

A remote version is recommended in the event of strong pipe vibrations.

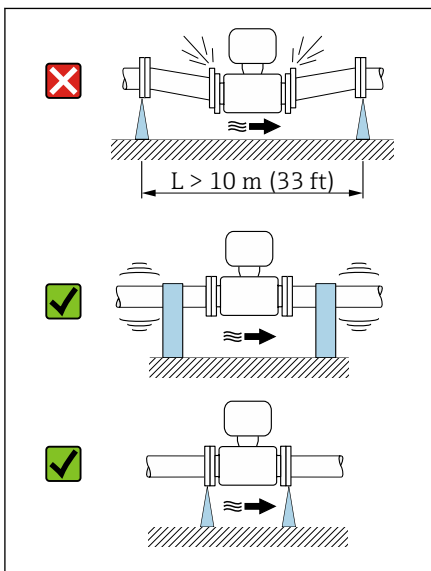

#### NOTICE

#### Pipe vibrations can damage the device!

- ▶ Do not expose the device to strong vibrations.
- ▶ Support the pipe and fix it in place.
- ▶ Support the device and fix it in place.
- ▶ Mount the sensor and transmitter separately.



### Adapters

Suitable adapters (double-flange reducers) can be used to install the sensor in larger-diameter pipes. The resulting higher rate of flow improves measuring accuracy with very slow-moving media.

**i** The nomogram shown here can be used to calculate the pressure loss caused by reducers and expanders. It only applies to liquids with a viscosity similar to that of water.

1. Calculate the ratio of the diameters  $d/D$ .
2. Determine the flow velocity after the reduction.
3. From the chart, determine the pressure loss as a function of the flow velocity  $v$  and the  $d/D$  ratio.

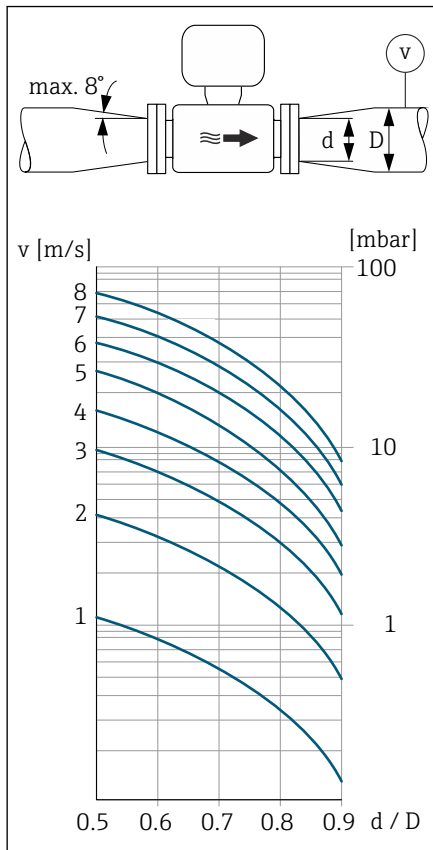

### Seals

Note the following when installing seals:

- For "PFA" liner: no seal is required.
- For "PTFE" liner: no seal is required.
- For DIN flanges: only install seals according to DIN EN 1514-1.

### Thermal insulation

The sensor and pipe must be insulated in the event of very hot media. The insulation helps to slow energy loss and prevent injuries from accidental contact with hot pipes.

#### NOTICE

**If the meter electronics overheat this can damage the device!**

- ▶ Keep the housing support completely free (heat dissipation).
- ▶ Provide insulation but make sure it does not go beyond the upper edge of the two sensor half-shells.

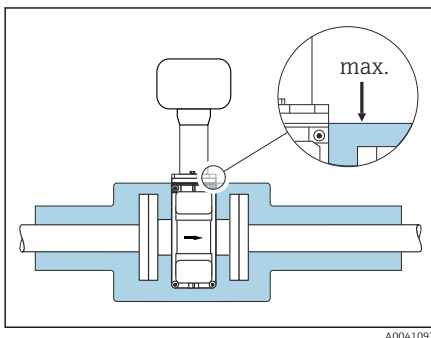

### Magnetism and static electricity

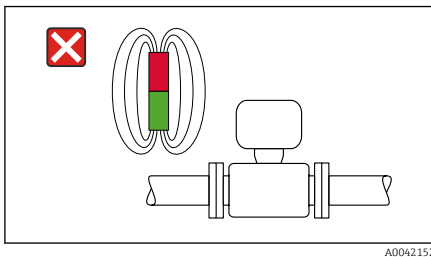

Do not install the device near magnetic fields, e.g. motors, pumps, transformers.

### Outdoor use

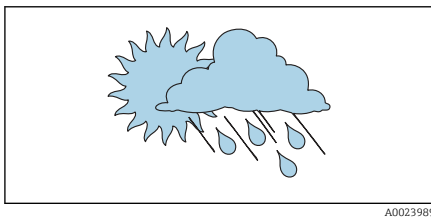

- Avoid exposure to direct sunlight.
- Install in a location protected from sunlight.
- Avoid direct exposure to weather conditions.
- Use a weather protection cover → *Transmitter*, 108.

### Immersion in water

**i** Only the remote version with IP68, type 6P, is suitable for immersion in water.

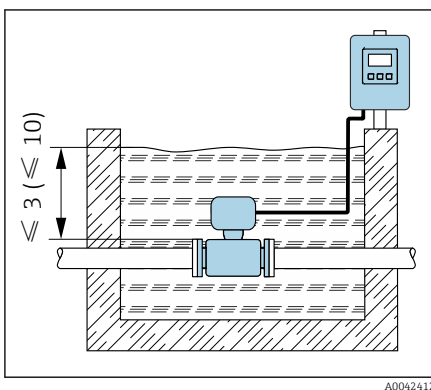

#### NOTICE

**If the maximum water depth and operating duration are exceeded, this will damage the device!**

- ▶ Observe the maximum water depth and operating duration.

#### Order code for "Sensor option", options CB, CC

Use of device under water at a maximum water depth of:

- 3 m (10 ft): permanent use
- 10 m (30 ft): max. 48 hours

#### Order code for "Sensor option", option CQ "Temporarily water-proof"

Temporary use of the device under non-corrosive water at a maximum water depth of:

- 3 m (10 ft): max. 168 hours

#### Order code for "Sensor option", options CD, CE

- For the operation of the device under water and in saline water

Operating duration at a maximum depth of:

- 3 m (10 ft): permanent use
- 10 m (30 ft): maximum 48 hours

### Use in buried applications

**i** Only the remote version with IP68 is suitable for use in buried applications.

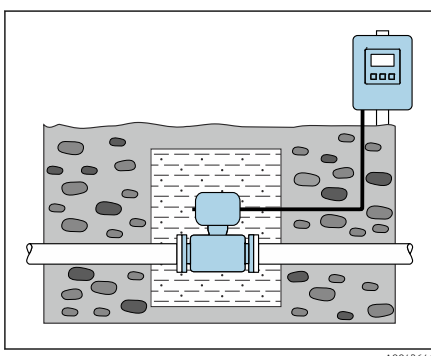

#### Order code for "Sensor option", options CD, CE

The device can be used in buried applications without the need to implement additional precautionary measures on the device.



Installation is performed according to regional installation regulations.

## Environment

---

Ambient temperature range	48
Storage temperature	48
Relative humidity	48
Operating height	48
Degree of protection	48
Vibration-resistance and shock-resistance	49
Electromagnetic compatibility (EMC)	49

## Ambient temperature range

<b>Transmitter</b>	-40 to +60 °C (-40 to +140 °F)
<b>Local display</b>	-20 to +60 °C (-4 to +140 °F) The readability of the display may be impaired at temperatures outside the temperature range.
<b>Sensor</b>	Process connection, carbon steel: -10 to +60 °C (+14 to +140 °F) Process connection, stainless steel: -40 to +60 °C (-40 to +140 °F)
<b>Liner</b>	Do not exceed or fall below the permitted temperature range of the liner .   Dependency of ambient temperature on medium temperature → <i>Medium temperature range</i> , 52  If using the device in hazardous areas, observe the "Safety Instructions" documentation.

## Storage temperature

The storage temperature corresponds to the ambient temperature range of the transmitter and sensor.

## Relative humidity

The device is suitable for use in outdoor and indoor areas with a relative humidity of 5 to 95%.

## Operating height

According to EN 61010-1

- Without overvoltage protection: ≤ 2 000 m
- With overvoltage protection: > 2 000 m

## Degree of protection

<b>Transmitter</b>	<ul style="list-style-type: none"> <li>■ IP66/67, Type 4X enclosure, suitable for pollution degree 4</li> <li>■ Open housing: IP20, Type 1 enclosure, suitable for pollution degree 2</li> </ul>	
<b>Sensor</b>	IP66/67, Type 4X enclosure, suitable for pollution degree 4	
<b>Optional sensor</b>		
Order code for "Sensor option", option CB, CC	IP68, Type 6P enclosure Fully welded, with protective coating as per EN ISO 12944 C5-M and EN 60529	Use of device under water at a maximum water depth of: <ul style="list-style-type: none"> <li>■ 3 m (10 ft): permanent use</li> <li>■ 10 m (30 ft): max. 48 hours</li> </ul>
Order code for "Sensor option", option CE, CG	IP68, type 6P enclosure Fully welded, with protective coating as per EN ISO 12944 Im2/Im3 and EN 60529	Use of the device in buried applications, under water and in saline water at a maximum water depth of: <ul style="list-style-type: none"> <li>■ 3 m (10 ft): permanent use</li> <li>■ 10 m (30 ft): max. 48 hours</li> <li>■ Use of device under water at a maximum water depth of: 10 m (30 ft): max. 48 hours</li> <li>■ Use of device in buried applications</li> </ul>
Order code for "Sensor option", option CQ	IP68, type 6P, temporarily waterproof	Temporary use of the device under non-corrosive water at a maximum water depth of: 3 m (10 ft): max. 168 hours

## Vibration-resistance and shock-resistance

### Compact version

<b>Vibration, sinusoidal</b> <ul style="list-style-type: none"> <li>▪ Following IEC 60068-2-6</li> <li>▪ 20 cycles per axis</li> </ul>	2 to 8.4 Hz	3.5 mm peak
	8.4 to 2 000 Hz	1 g peak
<b>Vibration, broad-band random</b> <ul style="list-style-type: none"> <li>▪ Following IEC 60068-2-64</li> <li>▪ 120 min per axis</li> </ul>	10 to 200 Hz	0.003 g <sup>2</sup> /Hz
	200 to 2 000 Hz	0.001 g <sup>2</sup> /Hz (1.54 g rms)
<b>Shocks, half-sine</b> <ul style="list-style-type: none"> <li>▪ Following IEC 60068-2-27</li> <li>▪ 3 positive and 3 negative shocks</li> </ul>	6 ms 30 g	

#### Shock

Due to rough handling according to IEC 60068-2-31.

### Remote version (sensor)

<b>Vibration, sinusoidal</b> <ul style="list-style-type: none"> <li>▪ Following IEC 60068-2-6</li> <li>▪ 20 cycles per axis</li> </ul>	2 to 8.4 Hz	7.5 mm peak
	8.4 to 2 000 Hz	2 g peak
<b>Vibration, broad-band random</b> <ul style="list-style-type: none"> <li>▪ Following IEC 60068-2-6</li> <li>▪ 120 min per axis</li> </ul>	10 to 200 Hz	0.01 g <sup>2</sup> /Hz
	200 to 2 000 Hz	0.003 g <sup>2</sup> /Hz (2.7 g rms)
<b>Shocks, half-sine</b> <ul style="list-style-type: none"> <li>▪ Following IEC 60068-2-6</li> <li>▪ 3 positive and 3 negative shocks</li> </ul>	6 ms 50 g	

#### Shock

Due to rough handling according to IEC 60068-2-31.

## Electromagnetic compatibility (EMC)

As per IEC/EN 61326 and NAMUR Recommendation NE 21.



For more information: Declaration of Conformity

## Process

---

Medium temperature range	52
Conductivity	53
Flow limit	53
Pressure-temperature ratings	54
Pressure tightness	56
Pressure loss	57

### Medium temperature range

The medium temperature range depends on the liner.

**PFA, DN 25 to 200 (1 to 8")**

-20 to +150 °C (-4 to +302 °F)

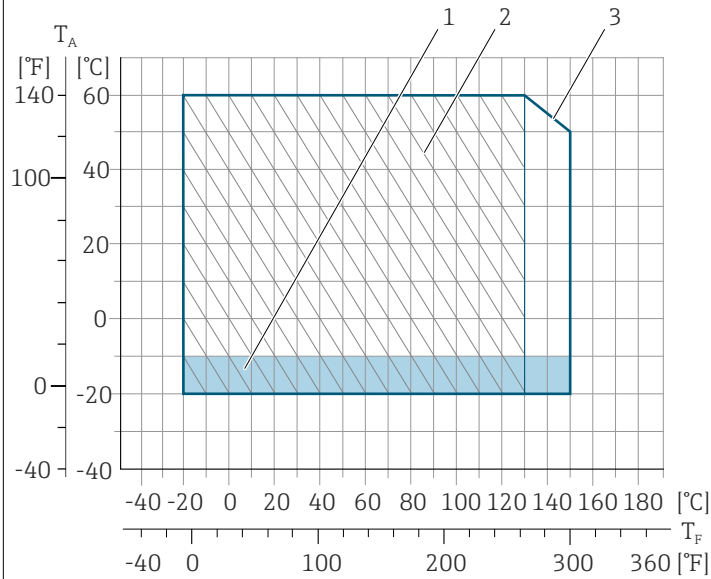

A0043553

$T_A$  Ambient temperature

$T_F$  Medium temperature

1 Colored area: the ambient temperature range -10 to -20 °C (+14 to -4 °F) applies to stainless flanges only

2 Hatched area: harsh environment only for medium temperature range -20 to +130 °C (-4 to +266 °F)

3 -20 to +150 °C (-4 to +302 °F)

**PTFE**

- -20 to +110 °C (-4 to +230 °F) (order code for "Liner", option 8)
- -40 to +130 °C (-40 to +266 °F) (order code for "Liner", option E)

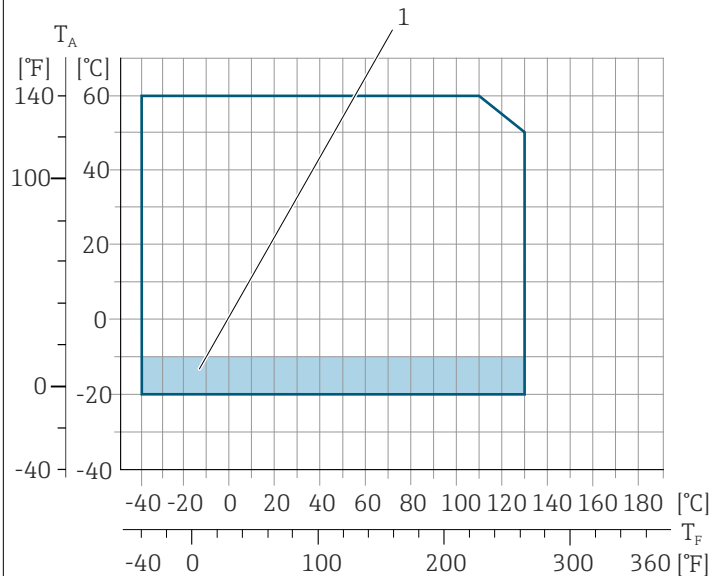

A0043555

$T_A$  Ambient temperature

$T_F$  Medium temperature

1 Colored area: the ambient temperature range of -10 to -20 °C (+14 to -4 °F) applies to stainless flanges only

### Conductivity

The minimum conductivity is:

- 5  $\mu\text{S}/\text{cm}$  for liquids in general
- 20  $\mu\text{S}/\text{cm}$  for demineralized water

The following basic conditions must be observed for  $< 20 \mu\text{S}/\text{cm}$ :

- Order code 013 for "Functionality", option D "Extended transmitter" and higher output signal damping is recommended for values under  $20 \mu\text{S}/\text{cm}$ .
- Observe the maximum permitted cable length  $L_{\text{max}}$ . This length is determined by the conductivity of the medium.
- With order code 013 "Functionality", option A "Standard transmitter" and empty pipe detection (EPD) switched on, the minimum conductivity is  $20 \mu\text{S}/\text{cm}$ .
- With order code 013 "Functionality", option A "Standard transmitter" - remote version, empty pipe detection may not be activated if  $L_{\text{max}} > 20 \text{ m}$ .

**i** Note that in the case of the remote version, the minimum conductivity depends on the cable length.

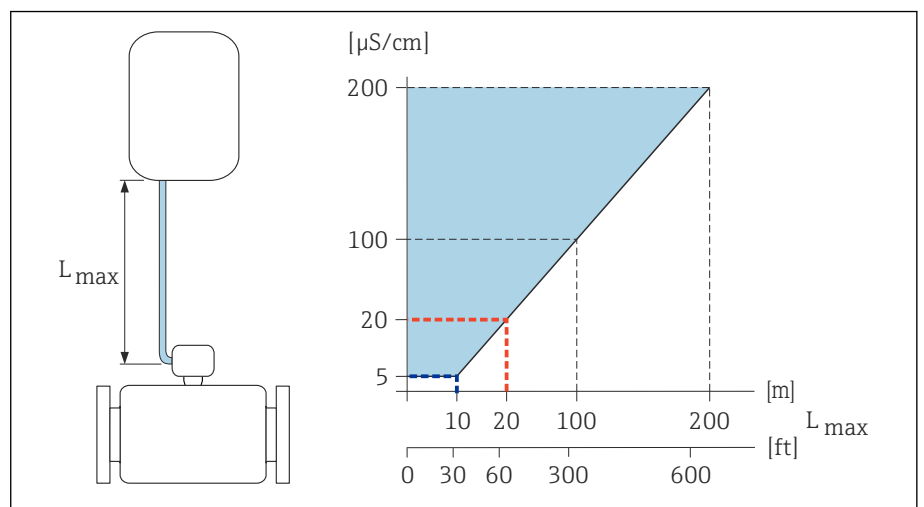

**4** Permitted length of connecting cable

Colored area = permitted range

$L_{\text{max}}$  = length of connecting cable in [m] ([ft])

[ $\mu\text{S}/\text{cm}$ ] = medium conductivity

Red line = order code 013 "Functionality", option A "Standard transmitter"

Blue line = order code 013 "Functionality", option D "Extended transmitter"

### Flow limit

Pipe diameter and flow rate determine the nominal diameter of the sensor.

**i** The flow velocity is increased by reducing the sensor nominal diameter.

2 to 3 m/s (6.56 to 9.84 ft/s)	Optimum flow velocity
$v < 2 \text{ m/s}$ (6.56 ft/s)	For abrasive media, e.g. potter's clay, lime milk, ore slurry
$v > 2 \text{ m/s}$ (6.56 ft/s)	For media producing buildup, e.g. wastewater sludge



### Pressure-temperature ratings

Maximum permitted medium pressure as a function of the medium temperature.

The data relate to all pressure bearing parts of the device.

#### Fixed flange according to EN 1092-1

Stainless steel (-20 °C (-4 °F))  
Carbon steel (-10 °C (14 °F))

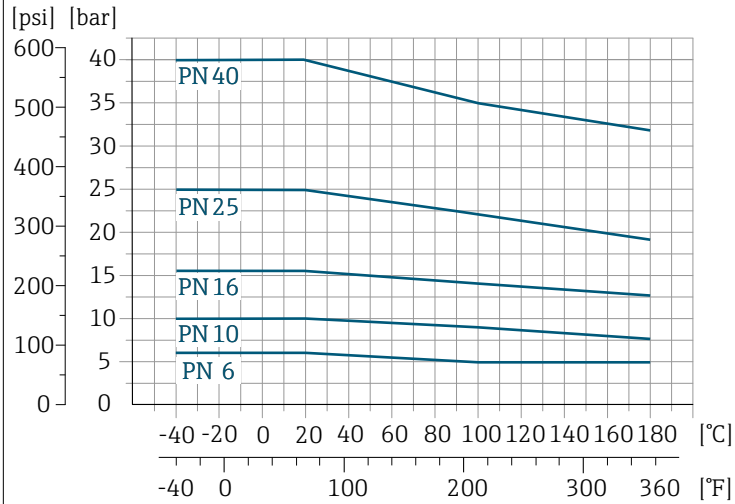

A0029391-EN

#### Fixed flange according to ASME B16.5

Stainless steel

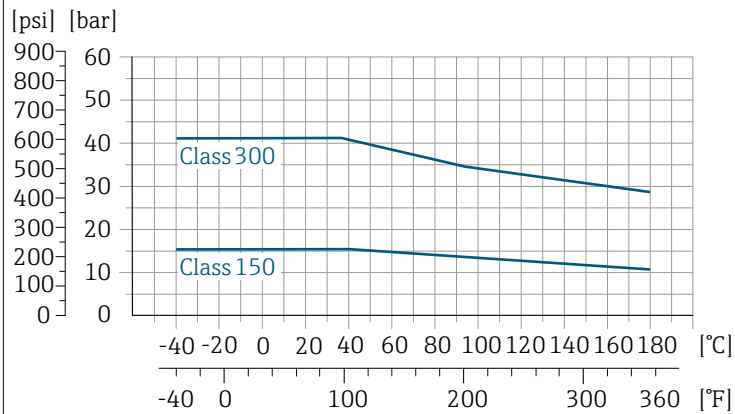

A0029394-EN

Carbon steel

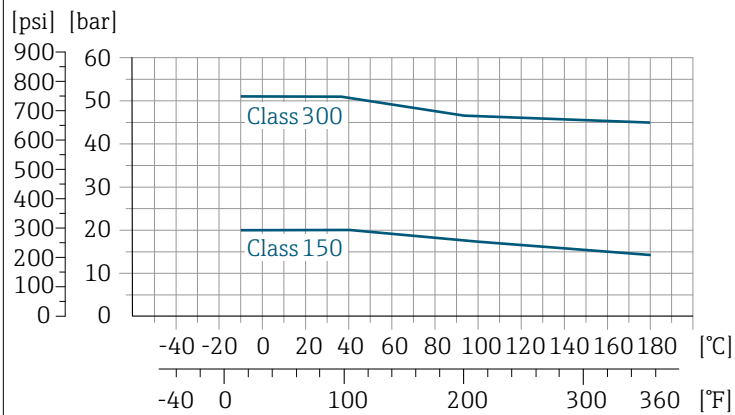

A0029393-EN

**Fixed flange according to JIS B2220**

Stainless steel (-20 °C (-4 °F))  
 Carbon steel (-10 °C (14 °F))

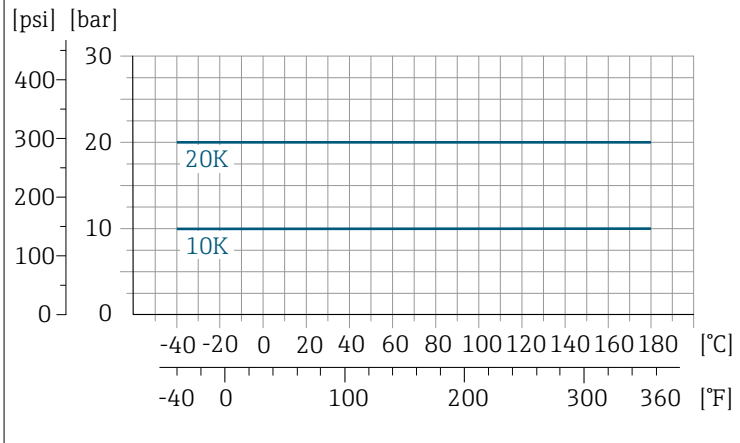

A0029397-EN

**Fixed flange according to AS 2129**

Carbon steel

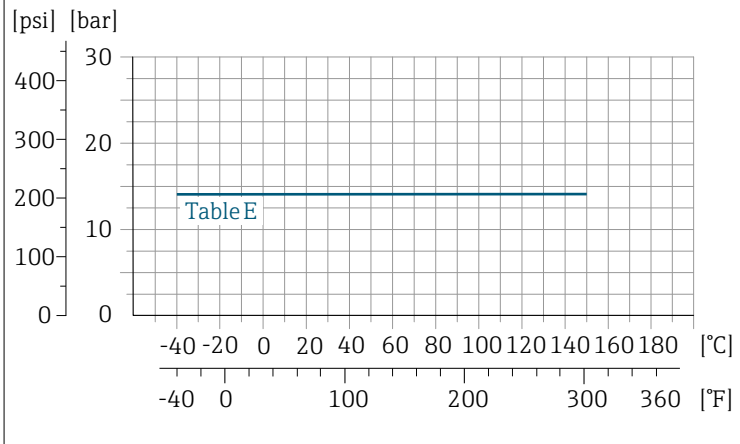

A0029398-EN

**Fixed flange according to AS 4087**

Carbon steel

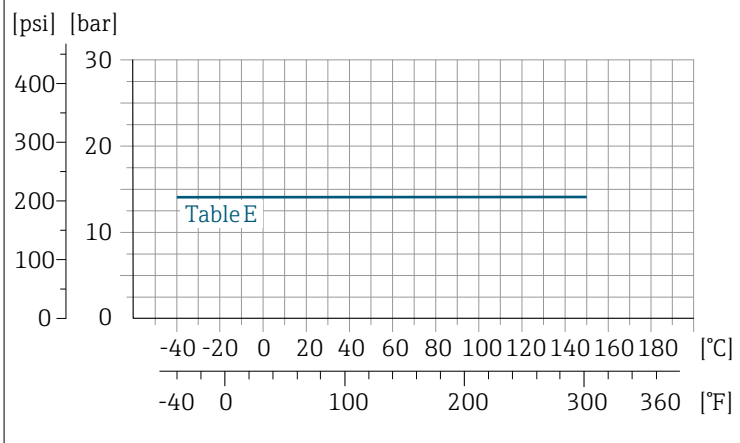

A0029398-EN

**Lap joint flange/lap joint flange, stamped plate according to EN 1092-1 and ASME B16.5**

Stainless steel (-20 °C (-4 °F))  
Carbon steel (-10 °C (14 °F))

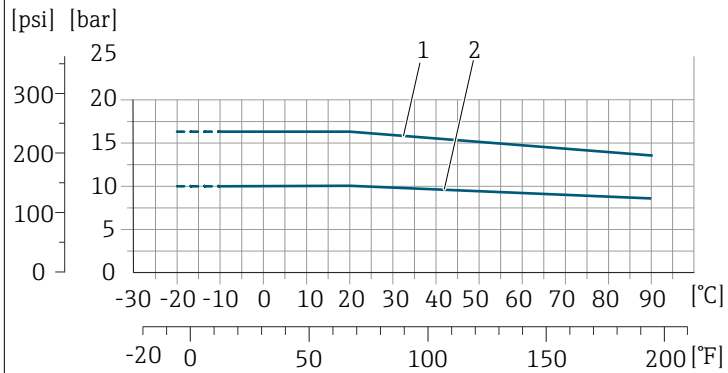

A0038129-EN

- 1 Lap joint flange PN16/Class150
- 2 Lap joint flange, stamped plate PN10, lap joint flange PN10

**Pressure tightness**

Limit values for the absolute pressure depending on the liner and medium temperature

PFA	Nominal diameter		Absolute pressure in [mbar] ([psi])		
	[mm]	[in]	+25 °C (+77 °F)	+80 °C (+176 °F)	+100 to +180 °C (+212 to +356 °F)
	25	1	0 (0)	0 (0)	0 (0)
	32	-	0 (0)	0 (0)	0 (0)
	40	1 ½	0 (0)	0 (0)	0 (0)
	50	2	0 (0)	0 (0)	0 (0)
	65	-	0 (0)	0 (0)	0 (0)
	80	3	0 (0)	0 (0)	0 (0)
	100	4	0 (0)	0 (0)	0 (0)
	125	-	0 (0)	0 (0)	0 (0)
	150	6	0 (0)	0 (0)	0 (0)
	200	8	0 (0)	0 (0)	0 (0)

PTFE	Nominal diameter		Limit values for absolute pressure in [mbar] ([psi]) for medium temperatures:			
	[mm]	[in]	+25 °C (+77 °F)	+80 °C (+176 °F)	+100 °C (+212 °F)	+130 °C (+266 °F)
	15	½	0 (0)	0 (0)	0 (0)	100 (1.45)
	25	1	0 (0)	0 (0)	0 (0)	100 (1.45)
	32	-	0 (0)	0 (0)	0 (0)	100 (1.45)
	40	1 ½	0 (0)	0 (0)	0 (0)	100 (1.45)
	50	2	0 (0)	0 (0)	0 (0)	100 (1.45)
	65	-	0 (0)	-	40 (0.58)	130 (1.89)
	80	3	0 (0)	-	40 (0.58)	130 (1.89)
	100	4	0 (0)	-	135 (1.96)	170 (2.47)
	125	-	135 (1.96)	-	240 (3.48)	385 (5.58)
	150	6	135 (1.96)	-	240 (3.48)	385 (5.58)
	200	8	200 (2.90)	-	290 (4.21)	410 (5.95)

PTFE	Nominal diameter		Limit values for absolute pressure in [mbar] ([psi]) for medium temperatures:			
	[mm]	[in]	+25 °C (+77 °F)	+80 °C (+176 °F)	+100 °C (+212 °F)	+130 °C (+266 °F)
	250	10	330 (4.79)	–	400 (5.80)	530 (7.69)
	300	12	400 (5.80)	–	500 (7.25)	630 (9.14)
	350	14	470 (6.82)	–	600 (8.70)	730 (10.6)
	400	16	540 (7.83)	–	670 (9.72)	800 (11.6)
	450	18	No negative pressure permitted!			
	500	20	No negative pressure permitted!			
	600	24	No negative pressure permitted!			

### Pressure loss

- No pressure loss: transmitter installed in a pipe with the same nominal diameter.
- Pressure loss information when adapters are used → *Adapters*, 44

## Mechanical construction

---

Weight	60
Measuring pipe specification	61
Materials	61
Fitted electrodes	63
Surface roughness	63

## Weight

All values refer to devices with flanges with a standard pressure rating.  
Weight data are guideline values. The weight may be lower than indicated depending on the pressure rating and design.

Different values due to different transmitter versions:

Transmitter version for the hazardous area: +1 kg (+2.2 lbs)

Transmitter version, order code for "Housing", option M "Polycarbonate": -1 kg (-2.2 lbs)

### Transmitter remote version

- Polycarbonate: 1.4 kg (3.1 lbs)
- Aluminum: 2.4 kg (5.3 lbs)

### Sensor remote version

Aluminum sensor connection housing: see the information in the following table.

## Weight in SI units

Nominal diameter		EN (DIN), AS <sup>1)</sup>		ASME		JIS	
[mm]	[in]	Pressure rating	[kg]	Pressure rating	[kg]	Pressure rating	[kg]
15	½	PN 40	7.2	Class 150	7.2	10K	4.5
25	1	PN 40	8.0	Class 150	8.0	10K	5.3
32	–	PN 40	8.7	Class 150	–	10K	5.3
40	1 ½	PN 40	10.1	Class 150	10.1	10K	6.3
50	2	PN 40	11.3	Class 150	11.3	10K	7.3
65	–	PN 16	12.7	Class 150	–	10K	9.1
80	3	PN 16	14.7	Class 150	14.7	10K	10.5
100	4	PN 16	16.7	Class 150	16.7	10K	12.7
125	–	PN 16	22.2	Class 150	–	10K	19
150	6	PN 16	26.2	Class 150	26.2	10K	22.5
200	8	PN 10	45.7	Class 150	45.7	10K	39.9
250	10	PN 10	65.7	Class 150	75.7	10K	67.4
300	12	PN 10	70.7	Class 150	111	10K	70.3
350	14	PN 10	105.7	Class 150	176	10K	79
400	16	PN 10	120.7	Class 150	206	10K	100
450	18	PN 10	161.7	Class 150	256	10K	128
500	20	PN 10	156.7	Class 150	286	10K	142
600	24	PN 10	208.7	Class 150	406	10K	188

1) For flanges according to AS, only DN 25 and 50 are available.

## Weight in US units

Nominal diameter		ASME	
[mm]	[in]	Pressure rating	[lbs]
15	½	Class 150	15.9
25	1	Class 150	17.6
40	1 ½	Class 150	22.3
50	2	Class 150	24.9
80	3	Class 150	32.4
100	4	Class 150	36.8
150	6	Class 150	57.7

Nominal diameter		ASME	
[mm]	[in]	Pressure rating	[lbs]
200	8	Class 150	101
250	10	Class 150	167
300	12	Class 150	244
350	14	Class 150	387
400	16	Class 150	454
450	18	Class 150	564
500	20	Class 150	630
600	24	Class 150	895

### Measuring pipe specification

Nominal diameter		Rating					Process connection internal diameter			
[mm]	[in]	EN (DIN)	ASME	AS 2129	AS 4087	JIS	PFA		PTFE	
		[bar]	[psi]	[bar]	[bar]	[bar]	[mm]	[in]	[mm]	[in]
15	½	PN 40	Class 150	-	-	20K	-	-	15	0.59
25	1	PN 40	Class 150	Table E	-	20K	23	0.91	26	1.02
32	-	PN 40	-	-	-	20K	32	1.26	35	1.38
40	1 ½	PN 40	Class 150	-	-	20K	36	1.42	41	1.61
50	2	PN 40	Class 150	Table E	PN 16	10K	48	1.89	52	2.05
65	-	PN 16	-	-	-	10K	63	2.48	67	2.64
80	3	PN 16	Class 150	-	-	10K	75	2.95	80	3.15
100	4	PN 16	Class 150	-	-	10K	101	3.98	104	4.09
125	-	PN 16	-	-	-	10K	126	4.96	129	5.08
150	6	PN 16	Class 150	-	-	10K	154	6.06	156	6.14
200	8	PN 10	Class 150	-	-	10K	201	7.91	202	7.95
250	10	PN 10	Class 150	-	-	10K	-	-	256	10.1
300	12	PN 10	Class 150	-	-	10K	-	-	306	12.0
350	14	PN 10	Class 150	-	-	10K	-	-	337	13.3
400	16	PN 10	Class 150	-	-	10K	-	-	387	15.2
450	18	PN 10	Class 150	-	-	10K	-	-	432	17.0
500	20	PN 10	Class 150	-	-	10K	-	-	487	19.2
600	24	PN 10	Class 150	-	-	10K	-	-	593	23.3

### Materials

Transmitter housing	
Order code for "Housing"	<ul style="list-style-type: none"> <li>■ Option A: aluminum, AlSi10Mg, coated</li> <li>■ Option M: polycarbonate</li> </ul>
Window material	<ul style="list-style-type: none"> <li>■ Order code for "Housing" option A: glass</li> <li>■ Order code for "Housing" option M: polycarbonate</li> </ul>
Sensor connection housing	
	Aluminum, AlSi10Mg, coated

**Cable glands and entries**

Cable gland M20×1.5	<ul style="list-style-type: none"> <li>■ Non-hazardous area: plastic</li> <li>■ Hazardous area: brass</li> </ul>
---------------------	--

Adapter for cable entry with female thread G ½" or NPT ½"	Nickel-plated brass
--	---------------------

**Connecting cable for remote version**

Electrode and coil current cable:  
PVC cable with copper shield

**Sensor housing**

DN 25 to 300 (1 to 12")	<ul style="list-style-type: none"> <li>■ Aluminum half-shell housing: aluminum, AlSi10Mg, coated</li> <li>■ Fully welded carbon steel housing with protective varnish</li> </ul>
-------------------------	--

DN 350 to 600 (14 to 24")	Fully welded carbon steel housing with protective varnish
---------------------------	---

**Measuring tubes**

DN 25 to 600 (1 to 24")	Stainless steel: 1.4301, 1.4306, 304, 304L
-------------------------	--

**Liner**

DN 25 to 200 (1 to 8")	PFA
------------------------	-----

DN 15 to 600 (1 to 24")	PTFE
-------------------------	------

**Electrodes**

- 1.4435 (316L)
- Alloy C22, 2.4602 (UNS N06022)
- Tantalum (only measuring electrode)
- Platinum (only measuring electrode)

**Seals**

As per DIN EN 1514-1, Form IBC

**Process connections**

EN 1092-1 (DIN 2501)	<p>Fixed flange</p> <ul style="list-style-type: none"> <li>■ Carbon steel: <ul style="list-style-type: none"> <li>■ DN ≤ 300: S235JRG2, S235JR+N, P245GH, A105, E250C</li> <li>■ DN 350 to 600: P245GH, S235JRG2, A105, E250C</li> </ul> </li> <li>■ Stainless steel: <ul style="list-style-type: none"> <li>■ DN ≤ 300: 1.4404, 1.4571, F316L</li> <li>■ DN 350 to 600: 1.4571, F316L, 1.4404</li> </ul> </li> </ul> <p>Lap joint flange</p> <ul style="list-style-type: none"> <li>■ Carbon steel DN ≤ 300: S235JRG2, A105, E250C</li> <li>■ Stainless steel DN ≤ 300: 1.4306, 1.4404, 1.4571, F316L</li> </ul> <p>Lap joint flange, stamped plate</p> <ul style="list-style-type: none"> <li>■ Carbon steel DN ≤ 300: S235JRG2 similar to S235JR+AR or 1.0038</li> <li>■ Stainless steel DN ≤ 300: 1.4301 similar to 304</li> </ul>
ASME B16.5	<ul style="list-style-type: none"> <li>■ Carbon steel: A105</li> <li>■ Stainless steel: F316L</li> </ul>
JIS B2220	<ul style="list-style-type: none"> <li>■ Carbon steel: A105, A350 LF2</li> <li>■ Stainless steel: F316L</li> </ul>
AS 2129	Carbon steel: A105, E250C, P235GH, P265GH, S235JRG2
AS 4087	Carbon steel: A105, P265GH, S275JR



Accessories	
Protective cover	Stainless steel, 1.4404 (316L)
Pipe mounting set	Stainless steel 1.4301 (304)
Wall mounting kit	Stainless steel 1.4301 (304)
Grounding rings	15 to 1200 mm (½ to 48 in) <ul style="list-style-type: none"> <li>▪ Stainless steel, 1.4435 (316L)</li> <li>▪ Alloy C22, 2.4602 (UNS N06022)</li> </ul>

### Fitted electrodes

Standard electrodes:

- Measuring electrodes
- Reference electrodes
- Empty pipe detection electrodes

### Surface roughness

All data relate to parts in contact with medium.

Stainless steel electrodes, 1.4435 (F316L); Alloy C22, 2.4602 (UNS N06022), platinum , tantalum

≤ 0.3 to 0.5 μm (11.8 to 19.7 μin)

Liner with PFA:

≤ 0.4 μm (15.7 μin)

## Dimensions in SI units

---

<b>Compact version</b>	<b>66</b>
Order code for "Housing", option A "Aluminum, coated"	66
Order code for "Housing", option A "Aluminum, coated"; Zone 1, Division 1	67
Order code for "Housing", option M "Compact, polycarbonate"	68
<b>Remote version</b>	<b>69</b>
Transmitter remote version	69
Sensor remote version	70
<b>Fixed flange</b>	<b>71</b>
Flange in accordance with EN 1092-1 (DIN 2501 / DIN 2512N): PN 10	71
Flange in accordance with EN 1092-1 (DIN 2501 / DIN 2512N): PN 16	72
Flange in accordance with EN 1092-1 (DIN 2501 / DIN 2512N): PN 25	73
Flange in accordance with EN 1092-1 (DIN 2501 / DIN 2512N): PN 40	74
Flange according to ASME B16.5, Class 150	75
Flange according to ASME B16.5, Class 300	76
Flange according to JIS B2220, 10K	77
Flange according to JIS B2220, 20K	78
Flange according to AS 2129, Tab. E	79
Flange according to AS 4087, PN 16	80
<b>Lap joint flange</b>	<b>81</b>
Lap joint flange in accordance with EN 1092-1 (DIN 2501 / DIN 2512N): PN 10	81
Lap joint flange in accordance with EN 1092-1 (DIN 2501 / DIN 2512N): PN 16	82
Lap joint flange according to ASME B16.5, Class 150	83
<b>Lap joint flange, stamped plate</b>	<b>84</b>
Lap joint flange, stamped plate in accordance with EN 1092-1 (DIN 2501 / DIN 2512N): PN 10	84
<b>Accessories</b>	<b>85</b>
Protective cover	85
Ground disks for flanges	85

### Compact version

Order code for "Housing", option A "Aluminum, coated"

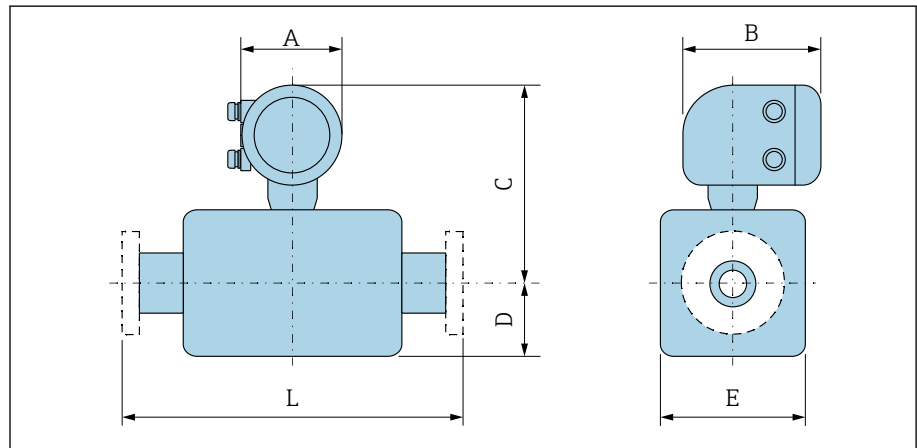

DN		A <sup>1)</sup>	B	C <sup>2)</sup>	D	E	L <sup>3)</sup>
[mm]	[in]	[mm]	[mm]	[mm]	[mm]	[mm]	[mm]
15	½	139	178	258	84	120	200
25	1	139	178	258	84	120	200
32	–	139	178	258	84	120	200
40	1 ½	139	178	258	84	120	200
50	2	139	178	258	84	120	200
65	–	139	178	283	109	180	200
80	3	139	178	283	109	180	200
100	4	139	178	283	109	180	250
125	–	139	178	323	150	260	250
150	6	139	178	323	150	260	300
200	8	139	178	348	180	324	350
250	10	139	178	373	205	400	450
300	12	139	178	398	230	460	500
350	14	139	178	457	282	564	550
400	16	139	178	483	308	616	600
450	18	139	178	508	333	666	650
500	20	139	178	533	359	717	650
600	24	139	178	586	411	821	780

- 1) Depending on the cable gland used: values up to +30 mm
- 2) With order code for "Sensor option", option CG "Sensor extended neck for insulation": values + 110 mm
- 3) Total installed length is independent of the process connections. Installed length according to DVGW (German Technical and Scientific Association for Gas and Water).

Order code for "Housing", option A "Aluminum, coated"; Zone 1, Division 1

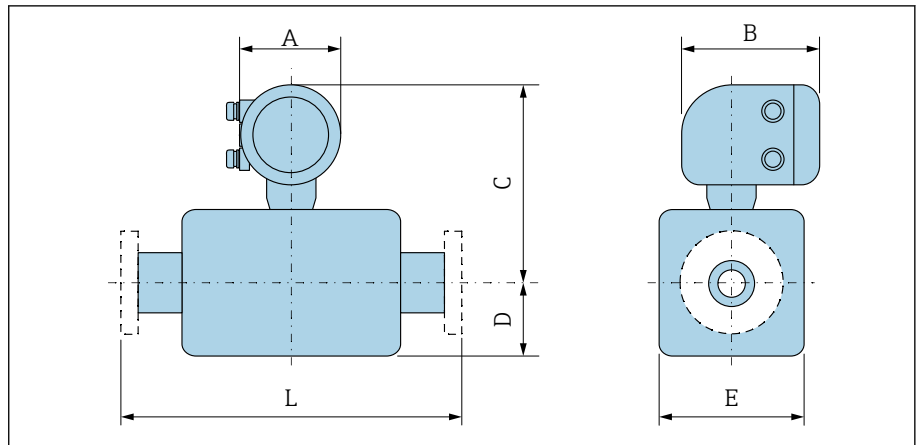

A0042708

DN		A <sup>1)</sup>	B <sup>2)</sup>	C <sup>3)</sup>	D	E	L <sup>4)</sup>
[mm]	[in]	[mm]	[mm]	[mm]	[mm]	[mm]	[mm]
15	½	139	206	281	84	120	200
25	1	139	206	281	84	120	200
32	-	139	206	281	84	120	200
40	1 ½	139	206	281	84	120	200
50	2	139	206	281	84	120	200
65	-	139	206	306	109	180	200
80	3	139	206	306	109	180	200
100	4	139	206	306	109	180	250
125	-	139	206	346	150	260	250
150	6	139	206	346	150	260	300
200	8	139	206	371	180	324	350
250	10	139	206	396	205	400	450
300	12	139	206	421	230	460	500
350	14	139	206	480	282	564	550
400	16	139	206	506	308	616	600
450	18	139	206	531	333	666	650
500	20	139	206	556	359	717	650
600	24	139	206	609	411	821	780

- 1) Depending on the cable gland used: values up to +30 mm
- 2) For Ex de: values +10 mm
- 3) With order code for "Sensor option", option CG "Sensor extended neck for insulation": values +110 mm
- 4) Total installed length is independent of the process connections. Installed length according to DVGW (German Technical and Scientific Association for Gas and Water).

Order code for "Housing", option M "Compact, polycarbonate"

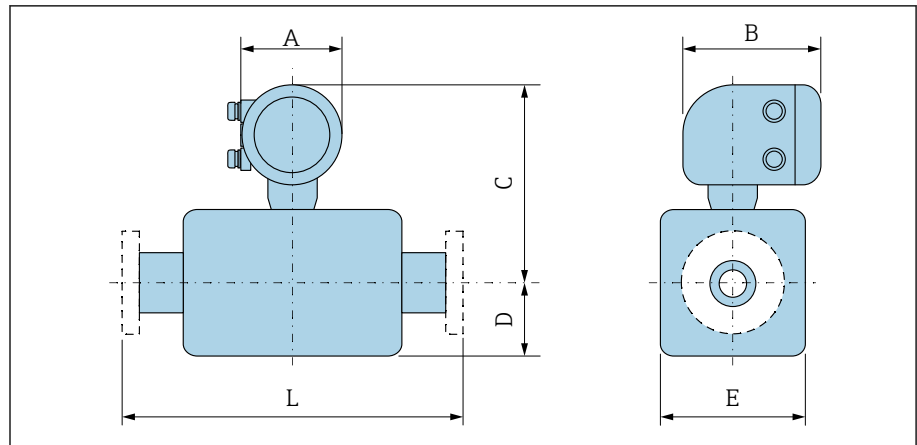

A0042708

DN		A <sup>1)</sup>	B	C <sup>2)</sup>	D	E	L <sup>3)</sup>
[mm]	[in]	[mm]	[mm]	[mm]	[mm]	[mm]	[mm]
15	½	132	172	255	84	120	200
25	1	132	172	255	84	120	200
32	–	132	172	255	84	120	200
40	1 ½	132	172	255	84	120	200
50	2	132	172	255	84	120	200
65	–	132	172	280	109	180	200
80	3	132	172	280	109	180	200
100	4	132	172	280	109	180	250
125	–	132	172	320	150	260	250
150	6	132	172	320	150	260	300
200	8	132	172	345	180	324	350
250	10	132	172	370	205	400	450
300	12	132	172	395	230	460	500
350	14	132	172	454	282	564	550
400	16	132	172	480	308	616	600
450	18	132	172	505	333	666	650
500	20	132	172	530	359	717	650
600	24	132	172	583	411	821	780

- 1) Depending on the cable gland used: values up to +30 mm
- 2) With order code for "Sensor option", option CG "Sensor extended neck for insulation": values + 110 mm
- 3) Total installed length is independent of the process connections. Installed length according to DVGW (German Technical and Scientific Association for Gas and Water).

## Remote version

### Transmitter remote version

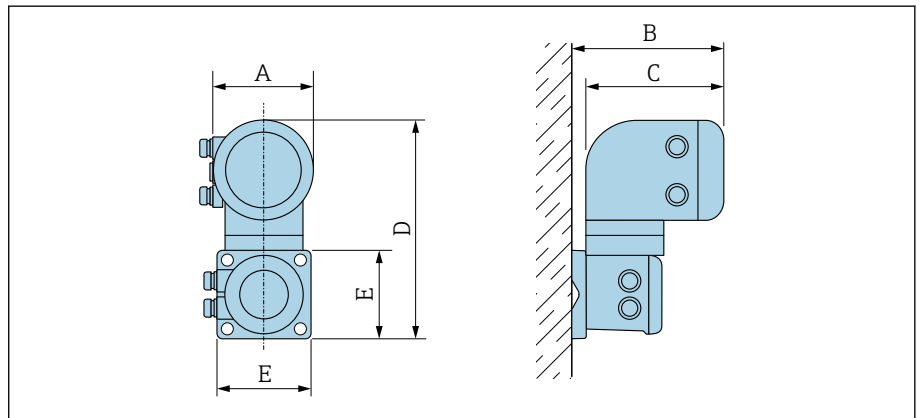

A0042715

Order code for "Housing"	A <sup>1)</sup> [mm]	B [mm]	C [mm]	D [mm]	E [mm]
Option N "Remote, polycarbonate"	132	187	172	307	130
Option P "Remote, aluminum, coated"	139	185	178	309	130

1) Depending on the cable entry used: values up to + 30 mm

## Sensor remote version

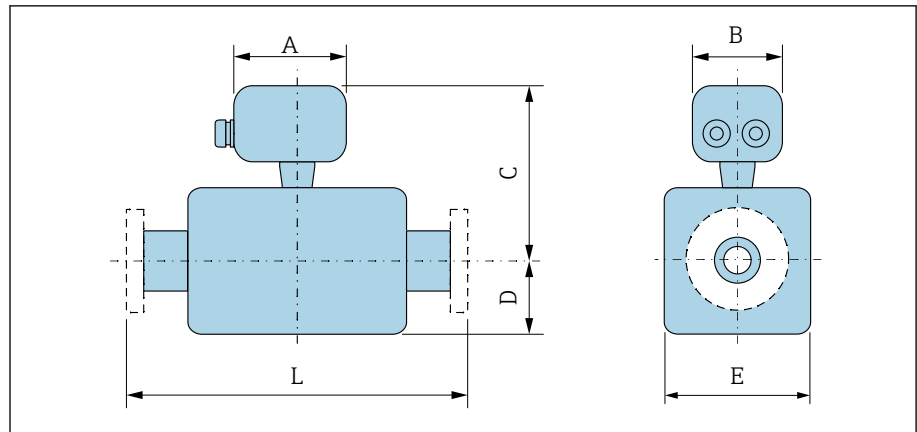

A0042718

DN		A <sup>1)</sup>	B	C <sup>2)</sup>	D	E	L <sup>3)</sup>
[mm]	[in]	[mm]	[mm]	[mm]	[mm]	[mm]	[mm]
15	½	148	136	197	84	120	200
25	1	148	136	197	84	120	200
32	–	148	136	197	84	120	200
40	1 ½	148	136	197	84	120	200
50	2	148	136	197	84	120	200
65	–	148	136	222	109	180	200
80	3	148	136	222	109	180	200
100	4	148	136	222	109	180	250
125	–	148	136	262	150	260	250
150	6	148	136	262	150	260	300
200	8	148	136	287	180	324	350
250	10	148	136	312	205	400	450
300	12	148	136	337	230	460	500
350	14	148	136	396	282	564	550
400	16	148	136	422	308	616	600
450	18	148	136	447	333	666	650
500	20	148	136	472	359	717	650
600	24	148	136	525	411	821	780

- 1) Depending on the cable gland used: values up to +30 mm
- 2) With order code for "Sensor option", option CG "Sensor extended neck for insulation" or order code for "Liner", option B "PFA high temperature": values +110 mm
- 3) Total installed length is independent of the process connections. Installed length according to DVGW (German Technical and Scientific Association for Gas and Water).

### Fixed flange

#### Flange in accordance with EN 1092-1 (DIN 2501 / DIN 2512N): PN 10

- Carbon steel: order code for "Process connection", option D2K
- Stainless steel: order code for "Process connection", option D2S

Surface roughness: EN 1092-1 Form B1 (DIN 2526 Form C), Ra 6.3 to 12.5 µm

E: Internal diameter depends on the liner → *Measuring pipe specification*, 61.

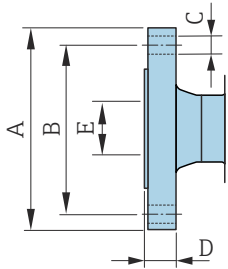

A0041915

DN [mm]	A [mm]	B [mm]	C [mm]	D [mm]
200	340	295	8 × Ø22	26
250	395	350	12 × Ø22	28
300	445	400	12 × Ø22	28
350	505	460	16 × Ø22	26
400	565	515	16 × Ø26	26
450	615	565	20 × Ø26	26
500	670	620	20 × Ø26	28
600	780	725	20 × Ø30	30



**Flange in accordance with EN 1092-1 (DIN 2501 / DIN 2512N): PN 16**

- Carbon steel: order code for "Process connection", option D3K
- Stainless steel: order code for "Process connection", option D3S

Surface roughness: EN 1092-1 Form B1 (DIN 2526 Form C), Ra 6.3 to 12.5 µm

E: Internal diameter depends on the liner → *Measuring pipe specification*, 61.

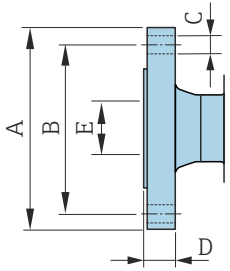

A0041915

DN [mm]	A [mm]	B [mm]	C [mm]	D [mm]
65	185	145	8 × Ø18	20
80	200	160	8 × Ø18	20
100	220	180	8 × Ø18	22
125	250	210	8 × Ø18	24
150	285	240	8 × Ø22	24
200	340	295	12 × Ø22	26
250	405	355	12 × Ø26	32
300	460	410	12 × Ø26	32
350	520	470	16 × Ø26	30
400	580	525	16 × Ø30	32
450	640	585	20 × Ø30	34
500	715	650	20 × Ø33	36
600	840	770	20 × Ø36	40

**Flange in accordance with EN 1092-1 (DIN 2501 / DIN 2512N): PN 25**

- Carbon steel: order code for "Process connection", option D4K
- Stainless steel: order code for "Process connection", option D4S

Surface roughness: EN 1092-1 Form B1 (DIN 2526 Form C), Ra 6.3 to 12.5 µm

E: Internal diameter depends on the liner → *Measuring pipe specification*, 61.

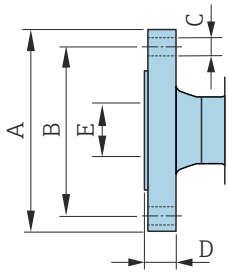

DN [mm]	A [mm]	B [mm]	C [mm]	D [mm]
200	360	310	12 × Ø26	32
250	425	370	12 × Ø30	36
300	485	430	16 × Ø30	40
350	555	490	16 × Ø33	38
400	620	550	16 × Ø36	40
450	670	600	20 × Ø36	46
500	730	660	20 × Ø36	48
600	845	770	20 × Ø39	48

**Flange in accordance with EN 1092-1 (DIN 2501 / DIN 2512N): PN 40**

- Carbon steel: order code for "Process connection", option D5K
- Stainless steel: order code for "Process connection", option D5S

Surface roughness: EN 1092-1 Form B1 (DIN 2526 Form C), Ra 6.3 to 12.5 µm

E: Internal diameter depends on the liner → *Measuring pipe specification*, 61.

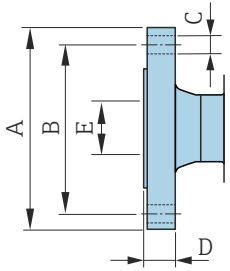

A0041915

DN [mm]	A [mm]	B [mm]	C [mm]	D [mm]
15	95	65	4 × Ø14	14
25	115	85	4 × Ø14	16
32	140	100	4 × Ø18	18
40	150	110	4 × Ø18	18
50	165	125	4 × Ø18	20
65	185	145	8 × Ø18	24
80	200	160	8 × Ø18	26
100	235	190	8 × Ø22	26
125	270	220	8 × Ø26	28
150	300	250	8 × Ø26	30

**Flange according to ASME B16.5, Class 150**

- Carbon steel: order code for "Process connection", option A1K
- Stainless steel: order code for "Process connection", option A1S

Surface roughness: Ra 6.3 to 12.5 µm

E: Internal diameter depends on the liner → *Measuring pipe specification*, 61

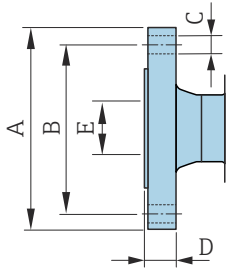

A0041915

DN [mm]	A [mm]	B [mm]	C [mm]	D [mm]
15	88.9	60.5	4 × Ø16	9.6
25	108	79.2	4 × Ø16	12.6
40	127	98.6	4 × Ø16	15.9
50	152.4	120.7	4 × Ø19.1	17.5
80	190.5	152.4	4 × Ø19.1	22.3
100	228.6	190.5	8 × Ø19.1	22.3
150	279.4	241.3	8 × Ø22.4	23.8
200	342.9	298.5	8 × Ø22.4	26.8
250	406.4	362	12 × Ø25.4	29.6
300	482.6	431.8	12 × Ø25.4	30.2
350	535	476.3	12 × Ø28.6	35.4
400	595	539.8	16 × Ø28.6	37
450	635	577.9	16 × Ø31.8	40.1
500	700	635	20 × Ø31.8	43.3
600	815	749.3	20 × Ø34.9	48.1

**Flange according to ASME B16.5, Class 300**

- Carbon steel: order code for "Process connection", option A2K
- Stainless steel: order code for "Process connection", option A2S

Surface roughness: Ra 6.3 to 12.5  $\mu\text{m}$

E: Internal diameter depends on the liner  $\rightarrow$  *Measuring pipe specification*,  61

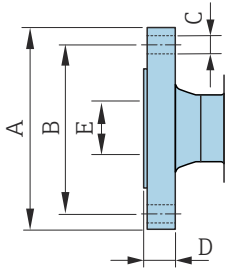

A0041915

DN [mm]	A [mm]	B [mm]	C [mm]	D [mm]
15	95.3	66.5	4 × Ø16	12.6
25	123.9	88.9	4 × Ø19.1	15.9
40	155.4	114.3	4 × Ø22.4	19
50	165.1	127	8 × Ø19.1	20.8
80	209.6	168.1	8 × Ø22.4	26.8
100	254	200.2	8 × Ø22.4	30.2
150	317.5	269.7	12 × Ø22.4	35

**Flange according to JIS B2220, 10K**

- Carbon steel: order code for "Process connection", option N3K
- Stainless steel: order code for "Process connection", option N3S

Surface roughness: Ra 6.3 to 12.5 µm

E: Internal diameter depends on the liner → *Measuring pipe specification*, 61

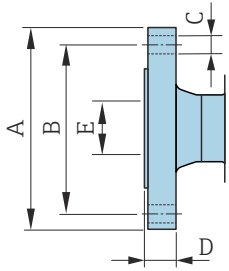

A0041915

DN [mm]	A [mm]	B [mm]	C [mm]	D [mm]
50	155	120	4 × Ø19	16
65	175	140	4 × Ø19	18
80	185	150	8 × Ø19	18
100	210	175	8 × Ø19	18
125	250	210	8 × Ø23	20
150	280	240	8 × Ø23	22
200	330	290	12 × Ø23	22
250	400	355	12 × Ø25	24
300	445	400	16 × Ø25	24

**Flange according to JIS B2220, 20K**

- Carbon steel: order code for "Process connection", option N4K
- Stainless steel: order code for "Process connection", option N4S

Surface roughness: Ra 6.3 to 12.5  $\mu\text{m}$

E: Internal diameter depends on the liner → *Measuring pipe specification*, 61

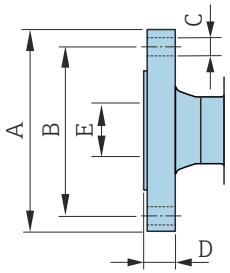

A0041915

DN [mm]	A [mm]	B [mm]	C [mm]	D [mm]
15	95	70	4 × Ø15	14
25	125	90	4 × Ø19	16
32	135	100	4 × Ø19	18
40	140	105	4 × Ø19	18
50	155	120	8 × Ø19	18
65	175	140	8 × Ø19	20
80	200	160	8 × Ø23	22
100	225	185	8 × Ø23	24
125	270	225	8 × Ø25	26
150	305	260	12 × Ø25	28
200	350	305	12 × Ø25	30
250	430	380	12 × Ø27	34
300	480	430	16 × Ø27	36

**Flange according to AS 2129, Tab. E**

Order code for "Process connection", option M2K

Surface roughness: Ra 6.3 to 12.5 µm

E: Internal diameter depends on the liner → *Measuring pipe specification*, 61.

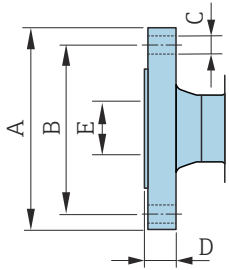

A0041915

DN [mm]	A [mm]	B [mm]	C [mm]	D [mm]
80	185	146	4 × Ø18	12
100	215	178	8 × Ø18	13
150	280	235	8 × Ø22	17
200	335	292	8 × Ø22	19
250	405	356	12 × Ø22	22
300	455	406	12 × Ø26	25
350	525	470	12 × Ø26	30
400	580	521	12 × Ø26	32
450	640	584	16 × Ø26	35
500	705	641	16 × Ø26	38
600	825	756	16 × Ø33	48



**Flange according to AS 4087, PN 16**

Order code for "Process connection", option M3K

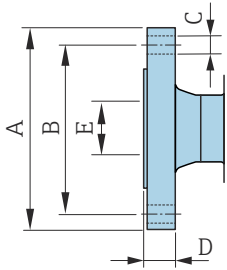
Surface roughness: Ra 6.3 to 12.5  $\mu\text{m}$ E: Internal diameter depends on the liner  $\rightarrow$  *Measuring pipe specification*, 61.

A0041915

DN [mm]	A [mm]	B [mm]	C [mm]	D [mm]
80	185	146	4 × Ø18	12
100	215	178	4 × Ø18	13
150	280	235	8 × Ø18	13
200	335	292	8 × Ø18	19
250	405	356	8 × Ø22	19
300	455	406	12 × Ø22	23
350	525	470	12 × Ø26	30
375	550	495	12 × Ø26	30
400	580	521	12 × Ø26	32
450	640	584	12 × Ø26	30
500	705	641	16 × Ø26	38
600	825	756	16 × Ø30	48

## Lap joint flange

### Lap joint flange in accordance with EN 1092-1 (DIN 2501 / DIN 2512N): PN 10

- Carbon steel: order code for "Process connection", option D22
- Stainless steel: order code for "Process connection", option D24

Surface roughness (flange): Ra 6.3 to 12.5 µm

F: Internal diameter depends on the liner → *Measuring pipe specification*, 61

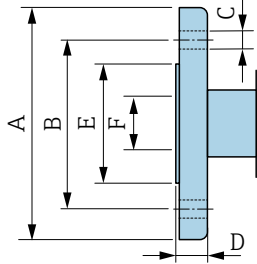

A0042254

DN [mm]	A [mm]	B [mm]	C [mm]	D [mm]	E [mm]
200	340	295	8 × Ø22	24	264
250	395	350	12 × Ø22	26	317
300	445	400	12 × Ø22	26	367

**Lap joint flange in accordance with EN 1092-1 (DIN 2501 / DIN 2512N): PN 16**

- Carbon steel: order code for "Process connection", option D32
- Stainless steel: order code for "Process connection", option D34

Surface roughness (flange): Ra 6.3 to 12.5  $\mu\text{m}$

F: Internal diameter depends on the liner  $\rightarrow$  *Measuring pipe specification*, 61

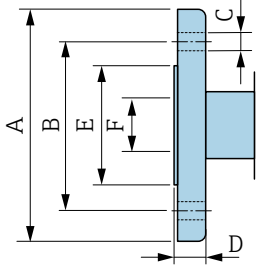

A0042254

DN [mm]	A [mm]	B [mm]	C [mm]	D [mm]	E [mm]
25	115	85	4 × Ø14	16	49
32	140	100	4 × Ø18	18	65
40	150	110	4 × Ø18	18	71
50	165	125	4 × Ø18	20	88
65	185	145	8 × Ø18	20	103
80	200	160	8 × Ø18	20	120
100	220	180	8 × Ø18	22	148
125	250	210	8 × Ø18	22	177
150	285	240	8 × Ø22	24	209
200	340	295	12 × Ø22	26	264
250	405	355	12 × Ø26	29	317
300	460	410	12 × Ø26	32	367

**Lap joint flange according to ASME B16.5, Class 150**

- Carbon steel: order code for "Process connection", option A12
- Stainless steel: order code for "Process connection", option A14

Surface roughness (flange): Ra 6.3 to 12.5 µm

F: Internal diameter depends on the liner → *Measuring pipe specification*, 61

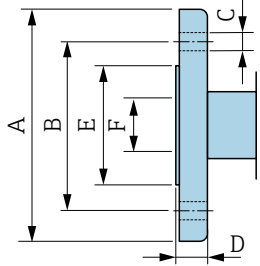

A0042254

DN [mm]	A [mm]	B [mm]	C [mm]	D [mm]	E [mm]
25	110	80	4 × Ø16	14	49
40	125	98	4 × Ø16	17.5	71
50	150	121	4 × Ø19	19	88
80	190	152	4 × Ø19	24	120
100	230	190	8 × Ø19	24	148
150	280	241	8 × Ø23	25	209
200	345	298	8 × Ø23	29	264
250	405	362	12 × Ø25	30	317
300	485	432	12 × Ø25	32	378

## Lap joint flange, stamped plate

### Lap joint flange, stamped plate in accordance with EN 1092-1 (DIN 2501 / DIN 2512N): PN 10

- Carbon steel: order code for "Process connection", option D21
- Stainless steel: order code for "Process connection", option D23

Surface roughness (flange): Ra 6.3 to 12.5 µm

F: Internal diameter depends on the liner → *Measuring pipe specification*, 61

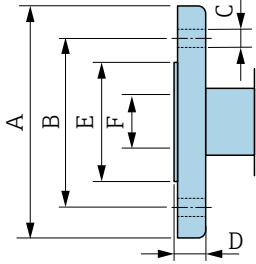

A0042254

DN [mm]	A [mm]	B [mm]	C [mm]	D [mm]	E [mm]
25	115	85	4 x Ø13.5	16.5	49
32	140	100	4 x Ø17.5	17	65
40	150	110	4 x Ø17.5	16.5	71
50	165	125	4 x Ø17.5	18.5	88
65	185	145	4 x Ø17.5	20	103
80	200	160	8 x Ø17.5	23.5	120
100	220	180	8 x Ø17.5	24.5	148
125	250	210	8 x Ø17.5	24	177
150	285	240	8 x Ø21.5	25	209
200	340	295	8 x Ø21.5	27.5	264
250	405	350	12 x Ø21.5	30.5	317
300	445	400	12 x Ø21.5	34.5	367



DN 300 to 600 (12 to 24")		DN		Rating	A	B	C <sup>1)</sup>	D	E	F
		[mm]	[in]		[mm]	[mm]	[mm]	[mm]	[mm]	[mm]
<p>A0042323</p>	300	12"	PN 25 JIS 10K JIS 20K	268	9	2	310	375	404	
	350	14"	PN 6 PN 10 PN 16	365	9	2	343	420	479	
	375	15"	PN 16	395	9	2	393	461	523	
	400	16"	PN 6 PN 10 PN 16	395	9	2	393	470	542	
	450	18"	PN 6 PN 10 PN 16	417	9	2	439	525	583	
	500	20"	PN 6 PN 10 PN 16	460	9	2	493	575	650	
	600	24"	PN 6 PN 10 PN 16	522	9	2	593	676	766	

1) Material thickness

## Dimensions in US units

---

<b>Compact version</b>	<b>88</b>
Order code for "Housing", option A "Aluminum, coated"	88
Order code for "Housing", option A "Aluminum, coated"; Zone 1, Division 1	89
Order code for "Housing", option M "Compact, polycarbonate"	90
<b>Remote version</b>	<b>91</b>
Transmitter remote version	91
Sensor remote version	92
<b>Fixed flange</b>	<b>93</b>
Flange according to ASME B16.5, Class 150	93
Flange according to ASME B16.5, Class 300	93
<b>Lap joint flange</b>	<b>94</b>
Lap joint flange according to ASME B16.5, Class 150	94
<b>Accessories</b>	<b>95</b>
Protective cover	95
Ground disks for flanges	95



## Compact version

Order code for "Housing", option A "Aluminum, coated"

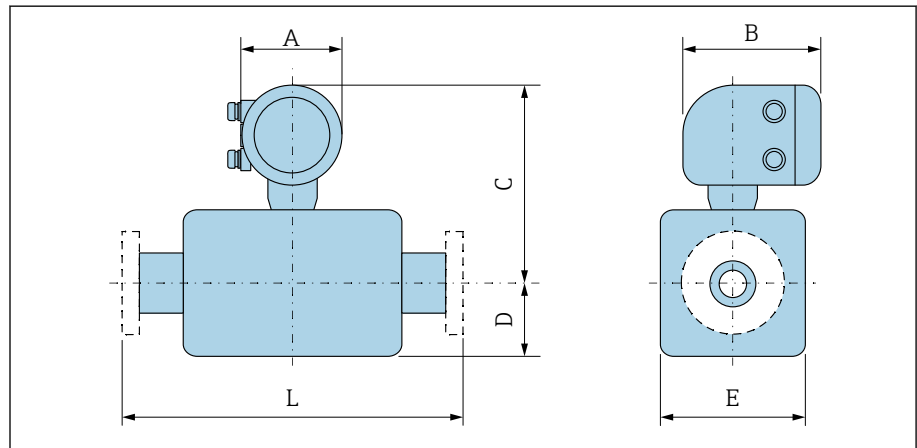

DN		A <sup>1)</sup>	B	C <sup>2)</sup>	D	E	L <sup>3)</sup>
[mm]	[in]	[in]	[in]	[in]	[in]	[in]	[in]
15	½	5.47	7.01	10.16	3.31	4.72	7.87
25	1	5.47	7.01	10.16	3.31	4.72	7.87
32	–	5.47	7.01	10.16	3.31	4.72	7.87
40	1 ½	5.47	7.01	10.16	3.31	4.72	7.87
50	2	5.47	7.01	10.16	3.31	4.72	7.87
65	–	5.47	7.01	11.14	4.29	7.09	7.87
80	3	5.47	7.01	11.14	4.29	7.09	7.87
100	4	5.47	7.01	11.14	4.29	7.09	9.84
125	–	5.47	7.01	12.72	5.91	10.24	9.84
150	6	5.47	7.01	12.72	5.91	10.24	11.81
200	8	5.47	7.01	13.7	7.09	12.76	13.78
250	10	5.47	7.01	14.69	8.07	15.75	17.72
300	12	5.47	7.01	15.67	9.06	18.11	19.69
350	14	5.47	7.01	17.99	11.1	22.2	21.65
400	16	5.47	7.01	19.02	12.13	24.25	23.62
450	18	5.47	7.01	20	13.11	26.22	25.59
500	20	5.47	7.01	20.98	14.13	28.23	25.59
600	24	5.47	7.01	23.07	16.18	32.32	30.71

- 1) Depending on the cable gland used: values up to +1.18 in
- 2) With order code for "Sensor option", option CG "Sensor extended neck for insulation": values +4.33 in
- 3) Total installed length is independent of the process connections. Installed length according to DVGW (German Technical and Scientific Association for Gas and Water).

Order code for "Housing", option A "Aluminum, coated"; Zone 1, Division 1

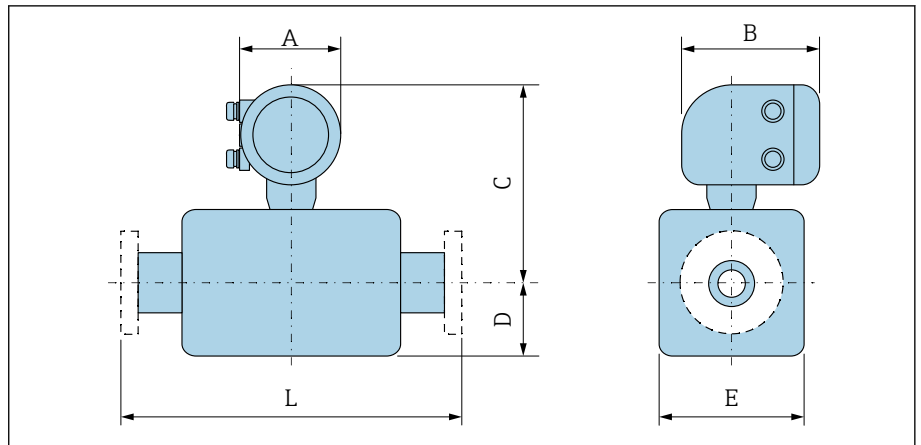

A0042708

DN		A <sup>1)</sup>	B <sup>2)</sup>	C <sup>3)</sup>	D	E	L <sup>4)</sup>
[mm]	[in]	[in]	[in]	[in]	[in]	[in]	[in]
15	½	5.47	8.11	11.06	3.31	4.72	7.87
25	1	5.47	8.11	11.06	3.31	4.72	7.87
32	–	5.47	8.11	11.06	3.31	4.72	7.87
40	1 ½	5.47	8.11	11.06	3.31	4.72	7.87
50	2	5.47	8.11	11.06	3.31	4.72	7.87
65	–	5.47	8.11	12.05	4.29	7.09	7.87
80	3	5.47	8.11	12.05	4.29	7.09	7.87
100	4	5.47	8.11	12.05	4.29	7.09	9.84
125	–	5.47	8.11	13.62	5.91	10.24	9.84
150	6	5.47	8.11	13.62	5.91	10.24	11.81
200	8	5.47	8.11	14.61	7.09	12.76	13.78
250	10	5.47	8.11	15.59	8.07	15.75	17.72
300	12	5.47	8.11	16.57	9.06	18.11	19.69
350	14	5.47	8.11	18.9	11.1	22.2	21.65
400	16	5.47	8.11	19.92	12.13	24.25	23.62
450	18	5.47	8.11	20.91	13.11	26.22	25.59
500	20	5.47	8.11	21.89	14.13	28.23	25.59
600	24	5.47	8.11	23.98	16.18	32.32	30.71

- 1) Depending on the cable gland used: values up to +1.18 in
- 2) For Ex de: values +0.39 in
- 3) With order code for "Sensor option", option CG "Sensor extended neck for insulation": values +4.33 in
- 4) Total installed length is independent of the process connections. Installed length according to DVGW (German Technical and Scientific Association for Gas and Water).

Order code for "Housing", option M "Compact, polycarbonate"

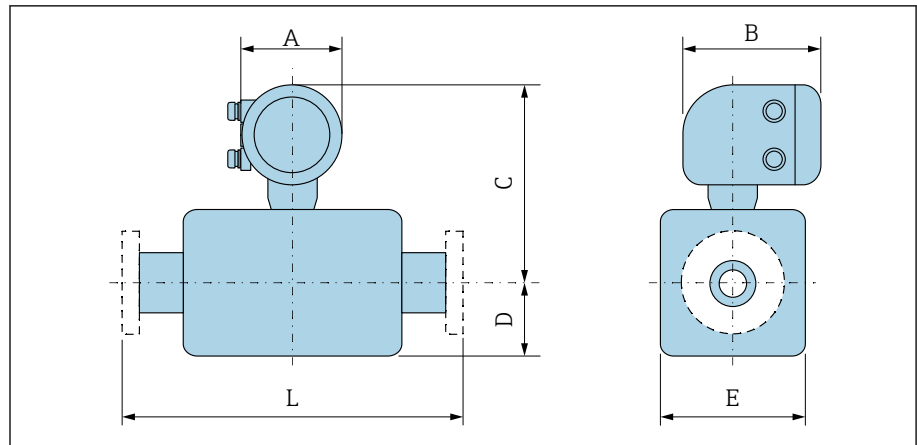

A0042708

DN		A <sup>1)</sup>	B	C <sup>2)</sup>	D	E	L <sup>3)</sup>
[mm]	[in]	[in]	[in]	[in]	[in]	[in]	[in]
15	½	5.2	6.77	10.04	3.31	4.72	7.87
25	1	5.2	6.77	10.04	3.31	4.72	7.87
32	–	5.2	6.77	10.04	3.31	4.72	7.87
40	1 ½	5.2	6.77	10.04	3.31	4.72	7.87
50	2	5.2	6.77	10.04	3.31	4.72	7.87
65	–	5.2	6.77	11.02	4.29	7.09	7.87
80	3	5.2	6.77	11.02	4.29	7.09	7.87
100	4	5.2	6.77	11.02	4.29	7.09	9.84
125	–	5.2	6.77	12.6	5.91	10.24	9.84
150	6	5.2	6.77	12.6	5.91	10.24	11.81
200	8	5.2	6.77	13.58	7.09	12.76	13.78
250	10	5.2	6.77	14.57	8.07	15.75	17.72
300	12	5.2	6.77	15.55	9.06	18.11	19.69
350	14	5.2	6.77	17.87	11.1	22.2	21.65
400	16	5.2	6.77	18.9	12.13	24.25	23.62
450	18	5.2	6.77	19.88	13.11	26.22	25.59
500	20	5.2	6.77	20.87	14.13	28.23	25.59
600	24	5.2	6.77	22.95	16.18	32.32	30.71

- 1) Depending on the cable gland used: values up to +1.18 in
- 2) With order code for "Sensor option", option CG "Sensor extended neck for insulation": values +4.33 in
- 3) Total installed length is independent of the process connections. Installed length according to DVGW (German Technical and Scientific Association for Gas and Water).

### Remote version

#### Transmitter remote version

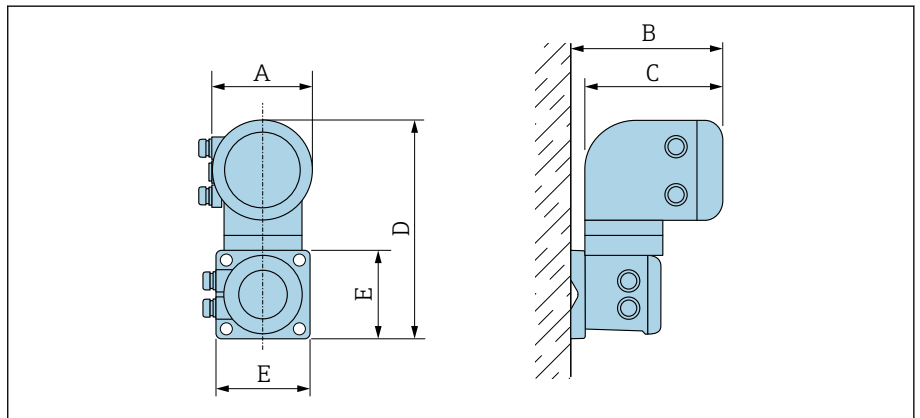

A0042715

Order code for "Housing"	A <sup>1)</sup> [in]	B [in]	C [in]	D [in]	E [in]
Option N "Remote, polycarbonate"	5.2	7.36	6.77	12.09	5.12
Option P "Remote, aluminum, coated"	5.47	7.28	7.01	12.17	5.12

1) Depending on the cable entry used: values up to +1.18 in

## Sensor remote version

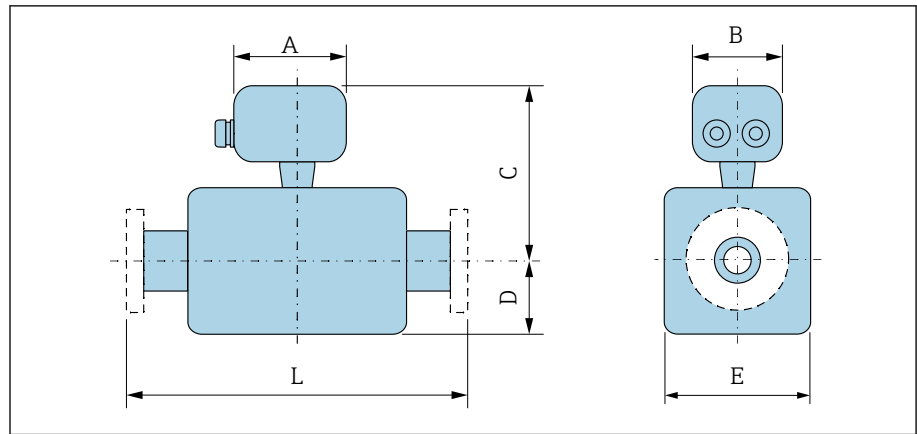

A0042718

DN		A <sup>1)</sup>	B	C <sup>2)</sup>	D	E	L <sup>3)</sup>
[mm]	[in]	[in]	[in]	[in]	[in]	[in]	[in]
15	½	5.83	5.35	7.76	3.31	4.72	7.87
25	1	5.83	5.35	7.76	3.31	4.72	7.87
32	–	5.83	5.35	7.76	3.31	4.72	7.87
40	1 ½	5.83	5.35	7.76	3.31	4.72	7.87
50	2	5.83	5.35	7.76	3.31	4.72	7.87
65	–	5.83	5.35	8.74	4.29	7.09	7.87
80	3	5.83	5.35	8.74	4.29	7.09	7.87
100	4	5.83	5.35	8.74	4.29	7.09	9.84
125	–	5.83	5.35	10.31	5.91	10.24	9.84
150	6	5.83	5.35	10.31	5.91	10.24	11.81
200	8	5.83	5.35	11.3	7.09	12.76	13.78
250	10	5.83	5.35	12.28	8.07	15.75	17.72
300	12	5.83	5.35	13.27	9.06	18.11	19.69
350	14	5.83	5.35	15.59	11.1	22.2	21.65
400	16	5.83	5.35	16.61	12.13	24.25	23.62
450	18	5.83	5.35	17.6	13.11	26.22	25.59
500	20	5.83	5.35	18.58	14.13	28.23	25.59
600	24	5.83	5.35	20.67	16.18	32.32	30.71

- 1) Depending on the cable gland used: values up to +1.18 in
- 2) With order code for "Sensor option", option CG "Sensor extended neck for insulation" or order code for "Liner", option B "PFA high temperature": values +4.33 in
- 3) Total installed length is independent of the process connections. Installed length according to DVGW (German Technical and Scientific Association for Gas and Water).

### Fixed flange

#### Flange according to ASME B16.5, Class 150

- Carbon steel: order code for "Process connection", option A1K
- Stainless steel: order code for "Process connection", option A1S

Surface roughness: Ra 250 to 492 µin

E: Internal diameter depends on the liner → *Measuring pipe specification*, 61

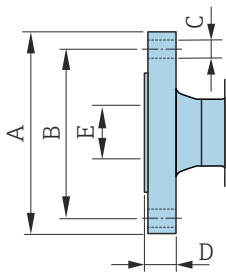

A0041915

DN [in]	A [in]	B [in]	C [in]	D [in]
½	3.50	2.38	4 × Ø0.63	0.38
1	4.25	3.12	4 × Ø0.63	0.5
1 ½	5	3.88	4 × Ø0.63	0.63
2	6	4.75	4 × Ø0.75	0.69
3	7.5	6	4 × Ø0.75	0.88
4	9	7.5	8 × Ø0.75	0.88
6	11	9.5	8 × Ø0.88	0.94
8	13.5	11.75	8 × Ø0.88	1.06
10	16	14.25	12 × Ø1	1.17
12	19	17	12 × Ø1	1.19
14	21.06	18.75	12 × Ø1.13	1.39
16	23.43	21.25	16 × Ø1.13	1.46
18	25	22.75	16 × Ø1.25	1.58
20	27.56	25	20 × Ø1.25	1.7
24	32.09	29.5	20 × Ø1.37	1.89

#### Flange according to ASME B16.5, Class 300

- Carbon steel: order code for "Process connection", option A2K
- Stainless steel: order code for "Process connection", option A2S

Surface roughness: Ra 250 to 492 µin

E: Internal diameter depends on the liner → *Measuring pipe specification*, 61

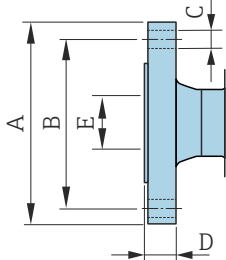

A0041915

DN [in]	A [in]	B [in]	C [in]	D [in]
½	3.75	2.62	4 × Ø0.63	0.50
1	4.88	3.5	4 × Ø0.75	0.63
1 ½	6.12	4.5	4 × Ø0.88	0.75
2	6.5	5	8 × Ø0.75	0.82
3	8.25	6.62	8 × Ø0.88	1.06
4	10	7.88	8 × Ø0.88	1.19
6	12.5	10.62	12 × Ø0.88	1.38

## Lap joint flange

### Lap joint flange according to ASME B16.5, Class 150

- **Carbon steel:** order code for "Process connection", option A12
- **Stainless steel:** order code for "Process connection", option A14

Surface roughness (flange): Ra 248 to 492  $\mu\text{in}$

F: Internal diameter depends on the liner  $\rightarrow$  *Measuring pipe specification*, 61

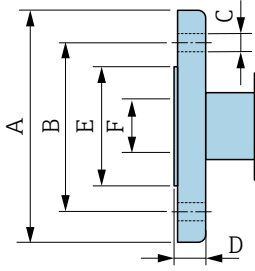

A0042254

DN [in]	A [in]	B [in]	C [in]	D [in]	E [in]
1	4.33	3.15	4 × Ø0.63	0.55	1.93
1 ½	4.92	3.86	4 × Ø0.63	0.69	2.8
2	5.91	4.76	4 × Ø0.75	0.75	3.46
3	7.48	5.98	4 × Ø0.75	0.94	4.72
4	9.06	7.48	8 × Ø0.75	0.94	5.83
6	11.02	9.49	8 × Ø0.91	0.98	8.23
8	13.58	11.73	8 × Ø0.91	1.14	10.39
10	15.94	14.25	12 × Ø0.98	1.18	12.48
12	19.09	17.01	12 × Ø0.98	1.26	14.88

Accessories

Protective cover

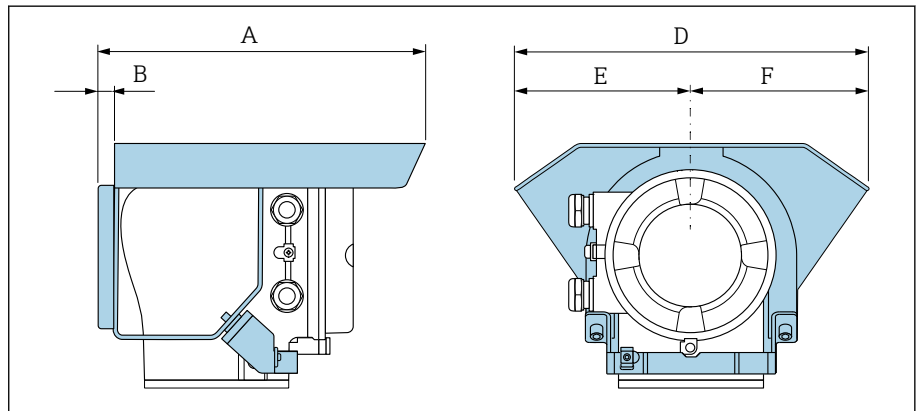

A0042332

A [in]	B [in]	D [in]	E [in]	F [in]
10.12	0.47	11.02	5.51	5.51

Ground disks for flanges

DN 15 to 300 (½ to 12")		DN	Pressure rating	A	B	C <sup>1)</sup>	D	E	F
		[mm]	[in]	[in]	[in]	[in]	[in]	[in]	[in]
<p>The drawing shows a ground disk with a central circular hole. Dimension A is the total height. Dimension B is the diameter of the top hole. Dimension C is the thickness of the disk. Dimension D is the diameter of the central hole. Dimension E is the diameter of the inner flange. Dimension F is the diameter of the outer flange.</p>	15	½"	2)	2.87	0.26	0.08	0.63	1.69	2.42
	25	1"	2)	3.44	0.26	0.08	1.02	2.44	3.05
	32	1 ¼"	2)	3.72	0.26	0.08	1.38	3.15	3.44
	40	1 ½"	2)	4.06	0.26	0.08	1.61	3.23	3.98
	50	2"	2)	4.25	0.26	0.08	2.05	3.98	4.55
	65	2 ½"	2)	4.65	0.26	0.08	2.68	4.76	5.18
	80	3"	2)	5.31	0.26	0.08	3.15	5.16	6.08
	100	4"	2)	6.02	0.26	0.08	4.09	6.14	7.34
	125	5"	2)	6.3	0.26	0.08	5.12	7.36	8.13
	150	6"	2)	7.24	0.26	0.08	6.22	8.54	10.08
	200	8"	2)	8.07	0.26	0.08	8.11	10.51	11.34
	250	10"	2)	9.45	0.26	0.08	10.24	12.91	14.13
300	12"	PN 10 PN 16 Cl. 150	10.75	0.26	0.08	12.28	14.76	16.26	

- 1) Material thickness
- 2) In the case of DN ½ to 10", ground disks can be used for all the flange standards/pressure ratings which can be supplied in the standard version.



DN 300 to 600 (12 to 24")		DN		Rating	A	B	C <sup>1)</sup>	D	E	F
		[mm]	[in]							
<p>A0042323</p>	300	12"	PN 25 JIS 10K JIS 20K	10.55	0.35	0.08	12.2	14.76	15.91	
	350	14"	PN 6 PN 10 PN 16	14.37	0.35	0.08	13.5	16.54	18.86	
	375	15"	PN 16	15.55	0.35	0.08	15.47	18.15	20.59	
	400	16"	PN 6 PN 10 PN 16	15.55	0.35	0.08	15.47	18.5	21.34	
	450	18"	PN 6 PN 10 PN 16	16.42	0.35	0.08	17.28	20.67	22.95	
	500	20"	PN 6 PN 10 PN 16	18.11	0.35	0.08	19.41	22.64	25.59	
	600	24"	PN 6 PN 10 PN 16	20.55	0.35	0.08	23.35	26.61	30.16	

1) Material thickness

## Local display

---

Operating concept	98
Operating options	98
Operating tools	99

## Operating concept

Operation method	<ul style="list-style-type: none"> <li>Operation via local display with touch screen.</li> <li>Operation via SmartBlue App.</li> </ul>
Menu structure	<p>Operator-oriented menu structure for user-specific tasks:</p> <ul style="list-style-type: none"> <li>Diagnostics</li> <li>Application</li> <li>System</li> <li>Guidance</li> <li>Language</li> </ul>
Commissioning	<ul style="list-style-type: none"> <li>Commissioning via a guided menu (<b>Commissioning</b> wizard).</li> <li>Menu guidance with interactive help function for individual parameters.</li> </ul>
Reliable operation	<ul style="list-style-type: none"> <li>Operation in local language.</li> <li>Uniform operating philosophy in device and in the SmartBlue App.</li> <li>Write protection</li> <li>When electronics modules are replaced: configurations are transferred using the T-DAT Backup device memory. The device memory contains process data, device data and the event logbook. No reconfiguration is necessary.</li> </ul>
Diagnostic behavior	<p>Efficient diagnostic behavior increases measurement availability:</p> <ul style="list-style-type: none"> <li>Open troubleshooting measures via local display and SmartBlue App.</li> <li>Diverse simulation options.</li> <li>Logbook of events that have occurred.</li> </ul>

## Operating options

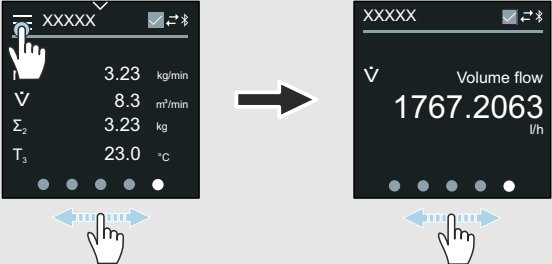
Local display	 <p>Display elements:</p> <ul style="list-style-type: none"> <li>LCD touch screen</li> <li>Depends on the orientation, automatic alignment of local display.</li> <li>Configuration of display format for measured variables and status variables.</li> </ul> <p>Operating elements:</p> <ul style="list-style-type: none"> <li>Touch screen</li> <li>Local display can also be accessed in the hazardous area.</li> </ul>
SmartBlue App	<ul style="list-style-type: none"> <li>The SmartBlue App allows the user to put devices into operation and operate them.</li> <li>Based on Bluetooth.</li> <li>No separate driver required.</li> <li>Available for mobile handheld terminals, tablets and smartphones.</li> <li>Suitable for convenient and secure access to devices in hard-to-reach locations or in hazardous areas.</li> <li>Can be used within a 20 m (65.6 ft) radius of the device.</li> <li>Encrypted and secure data transmission.</li> <li>No data loss during commissioning and maintenance.</li> <li>Diagnostic information and process information in real time.</li> </ul>

## Operating tools

Operating tools	Operating unit	Interface	Additional information
DeviceCare SFE100	<ul style="list-style-type: none"> <li>▪ Notebook</li> <li>▪ PC</li> <li>▪ Tablet with Microsoft Windows system</li> </ul>	<ul style="list-style-type: none"> <li>▪ CDI service interface</li> <li>▪ Fieldbus protocol</li> </ul>	Innovation brochure IN01047S
FieldCare SFE500	<ul style="list-style-type: none"> <li>▪ Notebook</li> <li>▪ PC</li> <li>▪ Tablet with Microsoft Windows system</li> </ul>	<ul style="list-style-type: none"> <li>▪ CDI service interface</li> <li>▪ Fieldbus protocol</li> </ul>	Operating Instructions BA00027S and BA00059S
SmartBlue App	<ul style="list-style-type: none"> <li>▪ Devices with iOS: iOS9.0 or higher</li> <li>▪ Devices with Android: Android 4.4 KitKat or higher</li> </ul>	Bluetooth	Endress+HauserSmartBlue App: <ul style="list-style-type: none"> <li>▪ Google Playstore (Android)</li> <li>▪ iTunes Apple Shop (iOS devices)</li> </ul>
Device Xpert	Field Xpert SFX 100/350/370	HART fieldbus protocol	Operating Instructions BA01202S

## Certificates and approvals

---

Ex approval	102
Non-Ex approval	102
Pressure Equipment Directive	102
HART certification	102
Radio approval	102
Additional approvals	102
Other standards and guidelines	102

### Ex approval

- ATEX
- IECEX
- cCSAus
- EAC
- NEPSI
- INMETRO
- JPN

### Non-Ex approval

- cCSAus
- EAC
- UK
- KC

### Pressure Equipment Directive

- CRN
- PED Cat. II/III

### HART certification

The device is certified and registered by the FieldComm Group. The measuring system meets all the requirements of the following specifications:

- Certified according to HART 7
- The device can also be operated with certified devices of other manufacturers (interoperability).

### Radio approval

The device has radio approvals.

### Additional approvals

- Food Contact Materials Regulation (EC) 1935/2004  
A declaration for a specific serial number that confirms compliance with the requirements of (EC) 1935/2004 is only generated for measuring devices with the order code for "Test, Certificate", option J1 "EU Food Contact Materials (EC) 1935/2004.
- FDA  
A declaration for a specific serial number that confirms compliance with FDA requirements is only generated for measuring devices with the order code for "Test, Certificate", option J2 "US Food Contact Materials FDA CFR 21".
- USP Class VI
- TSE/BSE Certificate of Suitability
- VDS (for stationary fire extinguishing systems)

### Other standards and guidelines

- IEC/EN 60529  
Degrees of protection provided by enclosures (IP code)
- IEC/EN 60068-2-6  
Environmental influences: Test procedure - Test Fc: vibrate (sinusoidal)
- IEC/EN 60068-2-31  
Environmental influences: Test procedure - Test Ec: shocks due to rough handling, primarily for devices.
- IEC/EN 61010-1  
Safety requirements for electrical equipment for measurement, control and laboratory use - general requirements.
- CAN/CSA-C22.2 No. 61010-1-12  
Safety Requirements for Electrical Equipment for Measurement, Control and Laboratory Use - Part 1 General Requirements.

- IEC/EN 61326  
Emission in accordance with Class A requirements. Electromagnetic compatibility (EMC requirements)
- ANSI/ISA-61010-1 (82.02.01)  
Safety Requirements for Electrical Equipment for Measurement, Control and Laboratory Use - Part 1 General Requirements.
- NAMUR NE 21  
Electromagnetic compatibility (EMC) of industrial process and laboratory control equipment.
- NAMUR NE 32  
Data retention in the event of a power failure in field and control instruments with microprocessors.
- NAMUR NE 43  
Standardization of the signal level for the breakdown information of digital transmitters with analog output signal.
- NAMUR NE 53  
Software of field devices and signal-processing devices with digital electronics.
- NAMUR NE 105  
Specifications for integrating fieldbus devices in engineering tools for field devices.
- NAMUR NE 107  
Self-monitoring and diagnosis of field devices.
- NAMUR NE 131  
Requirements for field devices for standard applications.
- ETSI EN 300 328  
Guidelines for 2.4 GHz radio components
- EN 301489  
Electromagnetic compatibility and radio spectrum matters (ERM).

## Application packages

---

Use	106
Heartbeat Verification + Monitoring	106



## Use

Many different application packages are available to enhance the functionality of the device. Such packages might be needed to address safety aspects or specific application requirements.

The application packages can be ordered with the device or subsequently from Endress+Hauser. Detailed information on the relevant order code is available from your local Endress+Hauser sales organization or on the product page of the Endress+Hauser website: [www.endress.com](http://www.endress.com).

## Heartbeat Verification + Monitoring

### Heartbeat Verification

Availability depends on the product structure.

Meets the requirement for traceable verification to DIN ISO 9001:2008 Chapter 7.6 a) "Control of monitoring and measuring equipment":

- Functional testing in the installed state without interrupting the process.
- Traceable verification results on request, including a report.
- Simple testing process with local operation or other operating interfaces.
- Clear measuring point assessment (pass/fail) with high test coverage within the framework of manufacturer specifications.
- Extension of calibration intervals according to operator's risk assessment.

### Heartbeat Monitoring

Availability depends on the product structure.

Heartbeat Monitoring continuously supplies data, which are characteristic of the measuring principle, to an external condition monitoring system for the purpose of preventive maintenance or process analysis. These data enable the operator to:

- Draw conclusions - using these data and other information - about the impact the process influences, e.g. corrosion, abrasion, formation of buildup, have on the measuring performance over time.
- Schedule servicing in time.
- Monitor the process quality or product quality, e.g. gas pockets.



## Accessories

---

Device-specific accessories	108
Communication-specific accessories	109
Service-specific accessory	109
System components	110

## Device-specific accessories







### Transmitter

Accessories	Description	Order number
Proline 10 transmitter	 Installation Instructions EA01350D	5XBBXX-*...*
Weather protection cover	Protects the device from weather exposure:  Installation Instructions EA01351D	71502730
Connecting cable	Can be ordered with the device. The following cable lengths are available: order code for "Cable, sensor connection" <ul style="list-style-type: none"> <li>▪ 5 m (16 ft)</li> <li>▪ 10 m (32 ft)</li> <li>▪ 20 m (65 ft)</li> <li>▪ User-configurable cable length (m or ft)</li> </ul>  Max. cable length: 200 m (660 ft)	DK5013-*...*
Ground cable	1 ground cable set for potential equalization, consisting of 2 ground cables	



### Sensor

Accessories	Description
Ground disks	Ground medium in lined measuring pipes.  Installation Instructions EA00070D



## Communication-specific accessories

Accessories	Description
Commubox FXA195 USB/HART modem	Intrinsically safe HART communication with FieldCare and FieldXpert  Technical Information TI00404F
Commubox FXA291	Connects the Endress+Hauser devices with the CDI interface (= Endress+Hauser Common Data Interface) to the USB interface of a personal computer or laptop.  Technical Information TI405C/07
HART Loop Converter HMX50	Is used to evaluate and convert dynamic HART process variables to analog current signals or limit values.  <ul style="list-style-type: none"> <li>▪ Technical Information TI00429F</li> <li>▪ Operating Instructions BA00371F</li> </ul>
Fieldgate FXA42	Transmission of measured values from connected 4 to 20 mA analog and digital devices.  <ul style="list-style-type: none"> <li>▪ Technical Information TI01297S</li> <li>▪ Operating Instructions BA01778S</li> <li>▪ Product page: <a href="http://www.endress.com/fxa42">www.endress.com/fxa42</a></li> </ul>
Field Xpert SMT70	Tablet PC for the configuration of the device. Enables mobile Plant Asset Management to manage the devices with a digital communication interface. Suitable for Zone 2.  <ul style="list-style-type: none"> <li>▪ Technical Information TI01342S</li> <li>▪ Operating Instructions BA01709S</li> <li>▪ Product page: <a href="http://www.endress.com/smt70">www.endress.com/smt70</a></li> </ul>
Field Xpert SMT77	Tablet PC for the configuration of the device. Enables mobile Plant Asset Management to manage the devices with a digital communication interface. Suitable for Zone 1.  <ul style="list-style-type: none"> <li>▪ Technical Information TI01418S</li> <li>▪ Operating Instructions BA01923S</li> <li>▪ Product page: <a href="http://www.endress.com/smt77">www.endress.com/smt77</a></li> </ul>

## Service-specific accessory

Accessories	Description	Order number
Applicator	Software for selecting and sizing Endress+Hauser devices.	<a href="https://portal.endress.com/webapp/applicator">https://portal.endress.com/webapp/applicator</a>
W@M Life Cycle Management	<ul style="list-style-type: none"> <li>▪ Information platform with software applications and services</li> <li>▪ Supports the entire life cycle of the facility.</li> </ul>	<a href="http://www.endress.com/lifecyclemanagement">www.endress.com/lifecyclemanagement</a>
FieldCare	FDT-based plant asset management software from Endress+Hauser. Management and configuration of Endress+Hauser devices.  Operating Instructions BA00027S and BA00059S	<ul style="list-style-type: none"> <li>▪ Device driver: <a href="http://www.endress.com">www.endress.com</a> → Download Area</li> <li>▪ CD-ROM (contact Endress+Hauser)</li> <li>▪ DVD (contact Endress+Hauser)</li> </ul>
DeviceCare	Software for connecting and configuring Endress+Hauser devices.  Innovation brochure IN01047S	<ul style="list-style-type: none"> <li>▪ Device driver: <a href="http://www.endress.com">www.endress.com</a> → Download Area</li> <li>▪ CD-ROM (contact Endress+Hauser)</li> <li>▪ DVD (contact Endress+Hauser)</li> </ul>

## System components

Accessories	Description
Memograph M	<p>Graphic data manager:</p> <ul style="list-style-type: none"><li>▪ Record measured values</li><li>▪ Monitor limit values</li><li>▪ Analyze measuring points</li></ul> <p> ▪ Technical Information TI00133R</p> <p> ▪ Operating Instructions BA00247R</p>
iTEMP	<p>Temperature transmitter:</p> <ul style="list-style-type: none"><li>▪ Measure the absolute pressure and gauge pressure of gases, vapors and liquids</li><li>▪ Read the medium temperature</li></ul> <p> "Fields of Activity" document FA00006T</p>